

17585

17586, 17587, 17588, 17589, 17593, 17618

ALL TILE ROOF HOOK FOR SIDE MOUNT RAILS; ADJUSTABLE



A DIVISION OF QUICKSCREWS INTERNATIONAL CORP

TABLE OF CONTENTS

3

SPEC SHEET

QTY & MEASUREMENT INFORMATION

4

UL CERTIFICATION

PROOF OF UL CERTIFICATION

6

INSTALLATION INSTRUCTIONS

STEP-BY-STEP-INSTALLATION GUIDE

7

BUILDING CODE LETTER

REGARDING STAMP DATES

8

TEST RESULTS

SUCH AS: WATER, UPLIFT, COMPRESSION, ETC.

26

AZ TEST RESULTS

SPECIFIC TESTING FOR ARIZONA COUNTIES

SPEC SHEET

Part #	Box Quantity	Screw Size
17585	10 Hooks	N/A
17586	1 Hook	N/A
17587	10 Hooks; 20 Screws	5/16" x 3"
17588	1 Hook; 2 Screws	5/16" x 3"
17589	10 Hooks; 20 Screws	#14 x 3"
17618	1 Hook; 2 Screws	#14 x 3"



Letter	Description	Size/Length
A	Mounting Screw Slot	9mm x 18mm
B	Rail Slot Size	10mm x 71mm
C	Length of Roof Hook	179.5mm
D	Bottom End to Top End	190.3mm - 198.5mm
E	Thickness	6mm
F	Adjustability Range	34mm - 42mm

UL Summary Data

Certificate Number E493748
Report Reference E493748-20170817
Date 2023-April-07

Use our #14 or 5/16" Solar Mounting Screws

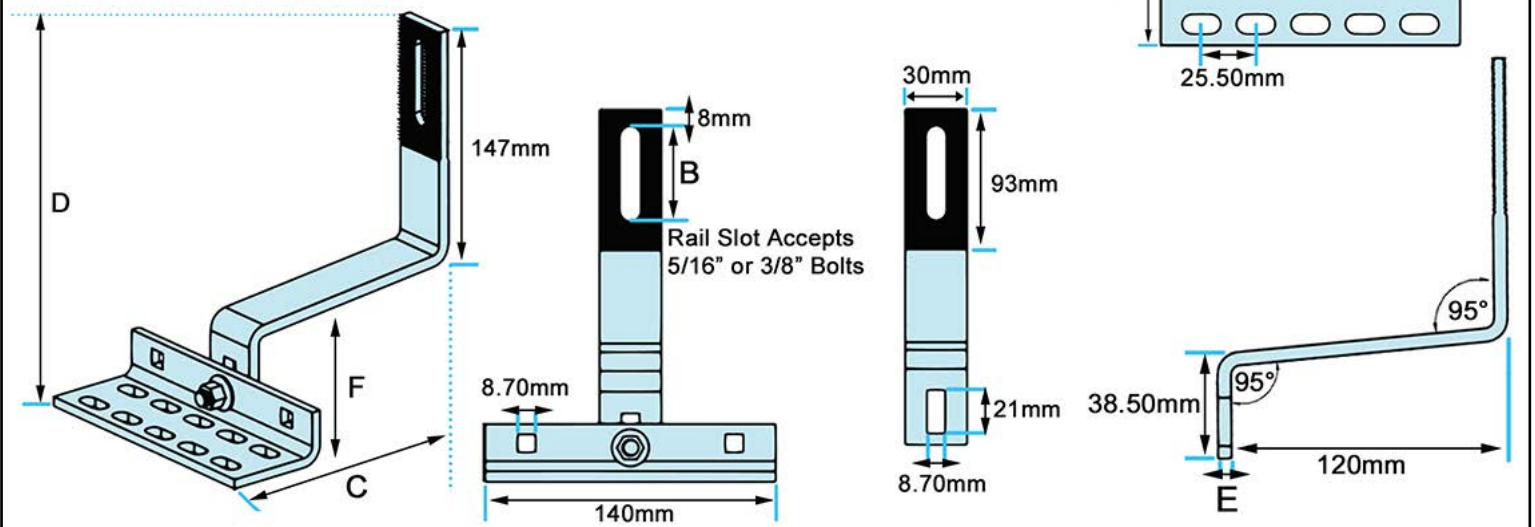

CERTIFICATE OF COMPLIANCE

Certificate Number E493748
Report Reference E493748-20170817
Date 2023-April-07

Issued to: QuickBOLT a Division of Quickscrews International Corp
5830 Las Positas Rd
Livermore CA, 94551 US

This is to certify that representative samples of MOUNTING SYSTEMS, MOUNTING DEVICES, CLAMPING DEVICES AND GROUND LUGS FOR USE WITH PHOTOVOLTAIC MODULES AND PANELS - COMPONENT
See Addendum Page for Product Designation(s).

Have been evaluated by UL in accordance with the component requirements in the Standard(s) indicated on this Certificate. UL Recognized components are incomplete in certain constructional features or restricted in performance capabilities and are intended for installation in complete equipment submitted for investigation to UL LLC.

Standard(s) for Safety: UL 2703, Mounting systems, mounting devices, clamping/retention devices, and ground lugs for use with flat-plate photovoltaic modules and panels-.

Additional Information: See the UL Online Certifications Directory at <https://iq.ulprospector.com> for additional information

This Certificate of Compliance indicates that representative samples of the product described in the certification report have met the requirements for UL certification. It does not provide authorization to apply the UL Recognized Component Mark. Only the Authorization Page that references the Follow-Up Services Procedure for ongoing surveillance provides authorization to apply the UL Mark.

Only those products bearing the UL Recognized Component Mark should be considered as being UL Certified and covered under UL's Follow-Up Services.

Look for the UL Recognized Component Mark on the product.



Deborah Jennings-Conner, VP Regulatory Services

UL LLC

Any information and documentation involving UL Mark services are provided on behalf of UL LLC (UL) or any authorized licensee of UL. For questions, please contact a local UL Customer Service Representative at <http://ul.com/about/locations/>



CERTIFICATE OF COMPLIANCE

Certificate Number E493748
Report Reference E493748-20170817
Date 2023-April-07

This is to certify that representative samples of the product as specified on this certificate were tested according to the current UL requirements

Models:

USR – Component, Roof Mounting Hook Units, Models 15891 15893 15987 16000 16317 16318
16319 16320 16988 16990 16991 16993 17508 17509 17510 17511 17512 17513 17514 17515
17516 17517 17518 17519 17520 17521 17522 17523 17524 17525 17526 17527 17536 17537
17538 17539 17540 17541 17542 17543 17544 17545 17546 17547 17548 17549 17550 17551
17552 17553 17554 17555 17556 17558 17559 17560 17566 17567 17568 17569 17570 17571
17572 17573 17574 17575 17576 17577 17578 17579 17580 17585 17586 17587 17588 17589
17592 17596 17597 17598 17599 17600 17601 17606 17607 17608 17609 17610 17611 17612
17613 17614 17615 17616 17617 17618 17620 17621 17622 17623 17624 17625 17626 17627
17628 17629 17630 17631 17632 17633 17636 17637 17638 17639 17640 17641 17642 17643
17646 17647 17648 17649 17650 17651 17652 17653 17654 17659 17664 17667 17669 17670
17671 17672 17673 17678 17679 17680 17681 17686 17687 17688 17689 17700 17701 17702
17703 17704 17705 17706 17707 17708 17709 17710 17711 17712 17717 17718 17750 17751
17752 17753 17759 15891-10 15891BLK-10 15987A 15987B 17667SS 17672SS 17680SS
17688SS 17713SS 17720 17721SS 17723 17724SS 17726 17727SS 17729 17730SS 15894SS
15891SS 15987BSS 17660 17661 17662 17663 17747 17748

Deborah Jennings-Conner

Deborah Jennings-Conner, VP Regulatory Services

UL LLC

Any information and documentation involving UL Mark services are provided on behalf of UL LLC (UL) or any authorized licensee of UL. For questions, please contact a local UL Customer Service Representative at <http://ul.com/about/locations/>



INSTALL INSTRUCTIONS



RECOMMENDED MATERIALS

- Rafter locator
- Chalk or crayon
- Drill Bit
- Sealant compatible with roofing materials



INSTALLATION INSTRUCTIONS

1. Remove the tiles from the install area
2. Locate and mark the rafters
3. Place the mount and predrill holes
4. Fill the predrilled holes with sealant
5. Drive the Mounting Screws
6. Place the tiles back over the roof mount



ADJUSTABLE HOOKS

- Adjust the mount as need be either before or after installation
- The ideal location for the mount on Curved Tiles is over the valley of the tile to minimize drainage



TORQUE REQUIREMENTS

M8 Bolt requires 1.5 minimum torque ft-lb

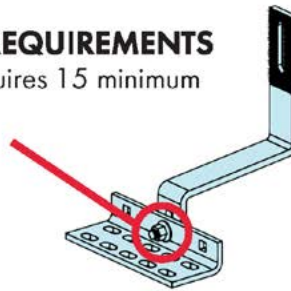

IF USING GALVA FLASHING

1. Make a cut in the paper
2. Apply sealant to the underside of the Galva Flashing
3. Slide the Flashing underneath the paper or nail down edges
4. Cover the edges of the Galva Flashing with sealant



www.quickbolt.com

BUILDING CODE LETTER



March 22nd, 2023

To whom this may concern,

QuickBOLT is committed to excellence. The parts tested are durable goods, meaning the material composition and detailed specifications of the parts do not change. Therefore, all stamps are current. Any part tested will have the same results no matter what year the tests are performed. All testing and reports are current and valid with 2022 CBC standards.

SolarRoofHook is the previous name of QuickBOLT. Any test result referencing SolarRoofHook is referring to a QuickBOLT product.

All our parts were tested by a third-party test facility, in possession of a current engineering license for the state where the tests were performed for the following.

1. Uplift test
2. Downward load test
3. Lateral Test – Asphalt Mounts, and Metal Mounts only
4. ASTM E2440 and ASTM E330 Waterproof Tests - QuickBOLT only

The following is an excerpt from:

CALIFORNIA BOARD FOR PROFESSIONAL ENGINEERS AND LAND SURVEYORS
guide to Engineering & Land Surveying for City and County Officials
Page 12, Line 27

27. If the license has expired between the time the engineering documents were prepared and the time when the local agency's review is performed, do the documents need to be re-sealed by a licensee with a current license? (B&P Code §§ 6733, 6735, 6735.3, 6735.4)

As long as the license was current at the time the engineering documents were prepared, the documents do not need to be re-sealed prior to review by the local agency. However, any changes (updates or modifications) to the documents that are made following the review by the local agency would have to be prepared by a licensed engineer with a current license and those changes would have to be signed and sealed.

We trust the information provided will resolve any request for the test reports submitted to have a stamp from the current year.

Regards,

Rick Gentry
Executive Vice President

ENGINEERING REPORT



APPLIED MATERIALS & ENGINEERING, INC.

980 41st Street
Oakland, CA 94608

Tel: (510) 420-8190
FAX: (510) 420-8186
e-mail: info@appmateng.com

September 17, 2015 *(Re-Issued on 4/4/2022)*

Mr. Rick Gentry
QUICKSCREWS INTERNATIONAL
5830 Las Positas Road
Livermore, CA 94551

Project Number 115727C

Subject: QS# 17585 –All Tile Roof Hook 90° Laboratory Load Testing

Dear Mr. Gentry:

As requested, Applied Materials & Engineering, Inc. (AME) has completed load-testing the All Tile Roof Hook 90° (see Appendix A, Figure 1). The purpose of our testing was to evaluate the compressive tensile (uplift) and shear (parallel to rafter) load capacity of the All Tile Roof Hook 90° attached to a 2"x4" Douglas Fir Rafter using two 5/16"Øx3" screws.

SAMPLE DESCRIPTION

Mockup samples were assembled in our laboratory on August 31, 2015. Mockup configuration consisted of three 12" long rafters at 4.5"o.c., screwed to 1/2" Structural I plywood. All Tile Roof Hook 90° is attached through the plywood into a rafter with two fasteners installed at the farthest end.

TEST PROCEDURES & RESULTS

1. Compressive Load Test

A total of three tests were conducted for compressive load capacity on September 11, 2015 using a United Universal testing machine. Samples were rigidly attached to the testing machine and a compressive load was applied to the hook. The samples were loaded in compression at a constant rate of axial deformation of 0.09 in. /min. without shock until the hook was bent and came in contact with the test board; displacement at maximum load was recorded. Based on the above testing, the average maximum compression load of the All Tile Roof Hook 90° attached to a 2"x4" Douglas Fir rafter using two 5/16"Øx3" screws was determined to be 395 lbf. Detailed results are provided in Table I. Test setup and mode of failure are provided in Appendix B, Figure 1.

The specific gravity and moisture content of the rafter was tested in accordance with ASTM D2395, Method A (oven-dry). The specific gravity and moisture content were determined to be 0.379 and 10.0%, respectively.

Mr. Rick Gentry
QUICKSCREWS INTERNATIONAL
5830 Las Positas Road
Livermore, CA 94551

Project Number 115727C

2. Tensile (Uplift) Load Test

A total of three tests were conducted for compressive load capacity on September 14, 2015 using a United Universal testing machine. Samples were rigidly attached to the testing machine and an uplift load was applied to the hook. The samples were loaded in tension at a constant rate of axial deformation of 0.09 in. /min. without shock until failure occurred; displacement at maximum load was recorded. Based on the above testing, the average maximum uplift load of the All Tile Roof Hook 90° attached to a 2"x4" Douglas Fir rafter using two 5/16"Øx3" screws was determined to be 2091 lbf. Detailed results are provided in Table II. Test setup and mode of failure are provided in Appendix B, Figure 2.

The specific gravity and moisture content of the rafter was tested in accordance with ASTM D2395, Method A (oven-dry). The specific gravity and moisture content were determined to be 0.383 and 11.5%, respectively.

3. Shear (Lateral) Load Test Parallel to Rafter

A total of three tests were conducted for shear load capacity on September 16, 2015 using a United Universal testing machine. Samples were rigidly attached to the testing machine and a shear load (parallel to rafter) was applied to the hook. The samples were loaded in shear at a constant rate of axial deformation of 0.09 in. /min. without shock until failure occurred; displacement at maximum load was recorded. Based on the above testing, the average maximum shear load (parallel to rafter) of the All Tile Roof Hook 90° attached to a 2"x4" Douglas Fir rafter using two 5/16"Øx3" screws was determined to be 487 lbf. Detailed results are provided in Table III. Test setup and mode of failure are provided in Appendix B, Figure 3.

The specific gravity and moisture content of the rafter was tested in accordance with ASTM D2395, Method A (oven-dry). The specific gravity and moisture content were determined to be 0.354 and 10.9%, respectively.

Respectfully Submitted,

APPLIED MATERIALS & ENGINEERING, INC.

Reviewed By:

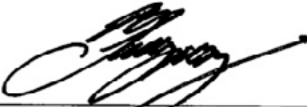
Mohammed Faiyaz, P.E.
Senior Engineer

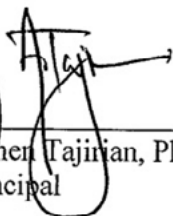

Armen Tajirian, Ph.D., P.E.
Principal

4/4/22

TABLE I
COMPRESSIVE LOAD TEST RESULTS
ALL TILE ROOF HOOK 90° (QS# 17585)
PROJECT NUMBER 115727C

SAMPLE ID	MAXIMUM COMPRESSIVE LOAD (lbf)	DISPLACEMENT AT MAXIMUM LOAD (in.)	FAILURE MODE
C-1	375	1.8	Hook contact w/Plywood
C-2	405	1.9	Hook contact w/Plywood
C-3	405	1.9	Hook contact w/Plywood
AVERAGE	395	1.9	..

TABLE II
TENSILE (UPLIFT) LOAD TEST RESULTS
ALL TILE ROOF HOOK 90° (QS# 17585)
PROJECT NUMBER 115727C

SAMPLE ID	MAXIMUM TENSILE LOAD (lbf)	DISPLACEMENT AT MAXIMUM LOAD (in.)	FAILURE MODE
T-1	1982	7.0	Fastener pullout
T-2	2138	6.6	Fastener pullout
T-3	2154	6.8	Fastener pullout
AVERAGE	2091	6.8	..

TABLE III
SHEAR (LATERAL) LOAD TEST RESULTS
PARALLEL TO RAFTER
ALL TILE ROOF HOOK 90° (OS# 17585)
PROJECT NUMBER 115727C

SAMPLE ID	MAXIMUM TENSILE LOAD (lbf)	DISPLACEMENT AT MAXIMUM LOAD (in.)	FAILURE MODE
S-1	474	9.7	Fastener shear
S-2	493	9.5	Fastener shear
S-3	495	9.7	Fastener shear
AVERAGE	487	9.6	..

REFERENCES

AC13-2010, “*Acceptance Criteria for Joist Hangers and Similar Devices*”, ICC Evaluation Service.

AC85-2008, “*Acceptance Criteria for Test Reports*”, ICC Evaluation Service.

ASTM D1761-2006, “*Standard Test Methods for Mechanical Fasteners in Wood*”, ASTM International.

ASTM D2395-2007, “*Standard Test Method for Specific Gravity of Wood and Wood-Based Materials*”,
ASTM International.

FIGURE 1
ALL TILE ROOF HOOK 90° (QS# 17585)
COMPRESSIVE LOAD TEST SETUP
PROJECT NUMBER 115727C



Figure1a. Test Setup Figure 1b.

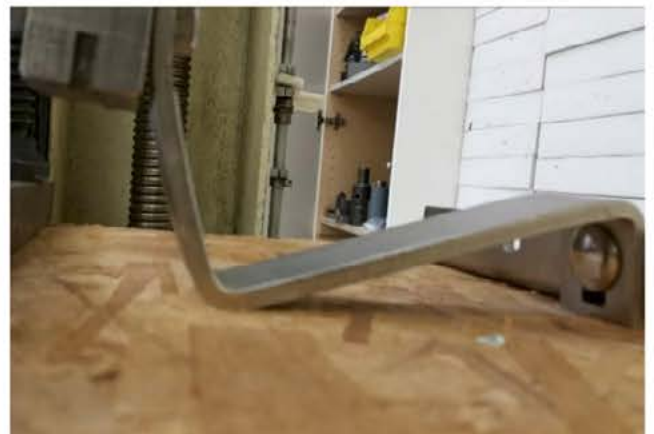

Typical Failure Mode

FIGURE 2
ALL TILE ROOF HOOK 90° (QS# 17585)
UPLIFT LOAD TEST SETUP
PROJECT NUMBER 115727C



Figure 2a. Test Setup



Figure 2b. Typical Failure Mode

FIGURE 3

ALL TILE ROOF HOOK 90° (QS# 17585)

SHEAR LOAD TEST SETUP
PARALLEL TO RAFTER

PROJECT NUMBER 115727C



Figure 3a. Test Setup

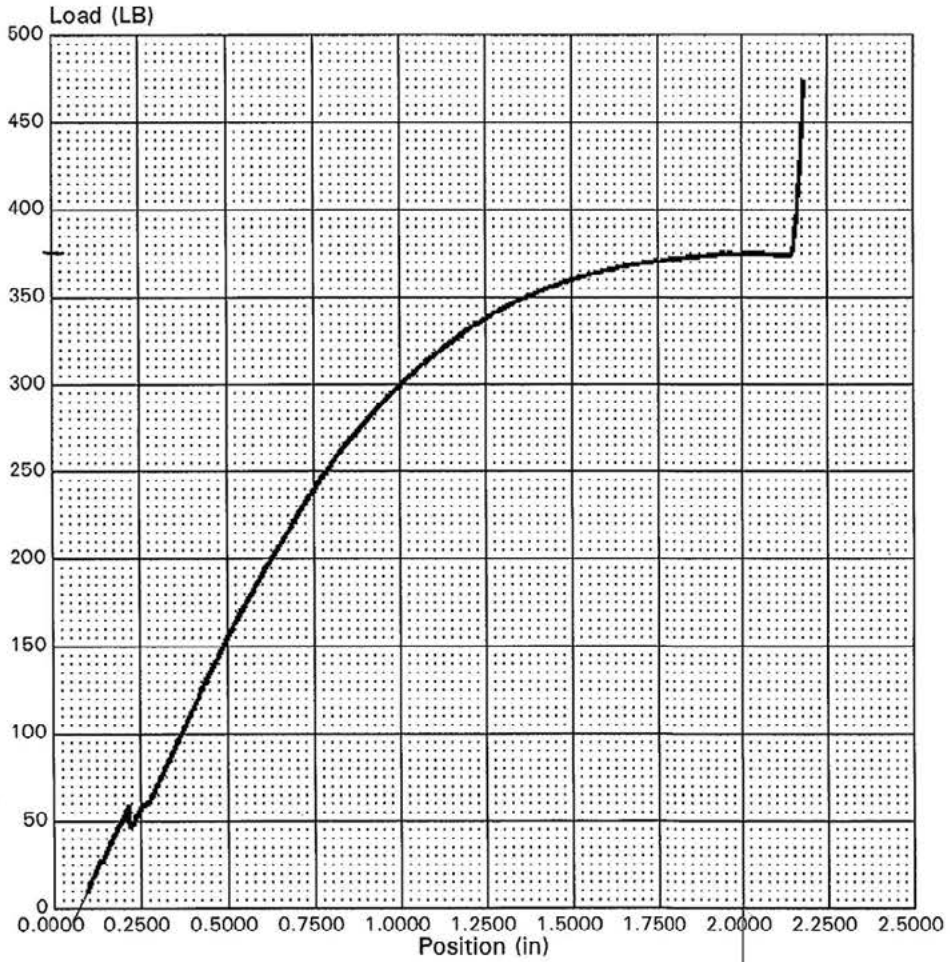

Figure 3b. Typical Failure Mode

RESULTS

Initials: DS Date: 9/11/15
LAB EQUIPMENT USED
Compression Machine:
ELE S/N 07010000077 _____
ELE S/N 00-13 _____
SATEC S/N 400HVL1075 _____
Unifed S/N 890212 X
Measurement:
Calliper S/N _____
Other:

All-tile Adjustable Hook
Compression #1



RESULTS

Initials: DS Date: 9/11/15
LAB EQUIPMENT USED
Compression Machine:
ELE S/N 070100000077 _____
ELE S/N 00-13 _____
SATEC S/N 400HVL1075 _____
United S/N 890212 X _____
Measurement:
Caliper S/N _____
Other:

All-tile Adjustable Hook
Compression #2

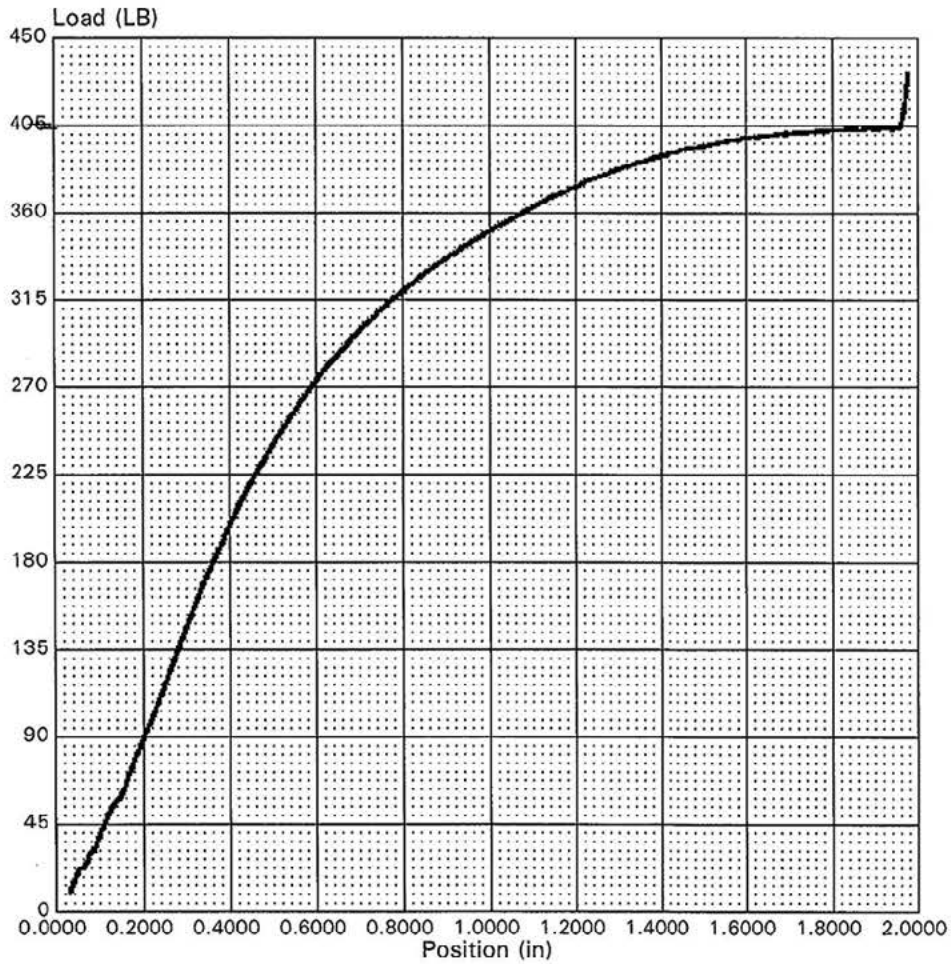

1.9

RESULTS

Initials: DS Date: 9/11/15
LAB EQUIPMENT USED
Compression Machine:
ELE S/N 070100000077 _____
ELE S/N 00-13 _____
SATEC S/N 400HVL1075 _____
United S/N 890212 X _____
Measurement:
Caliper S/N _____
Other:

All-tile Adjustable Hook
Compression #3

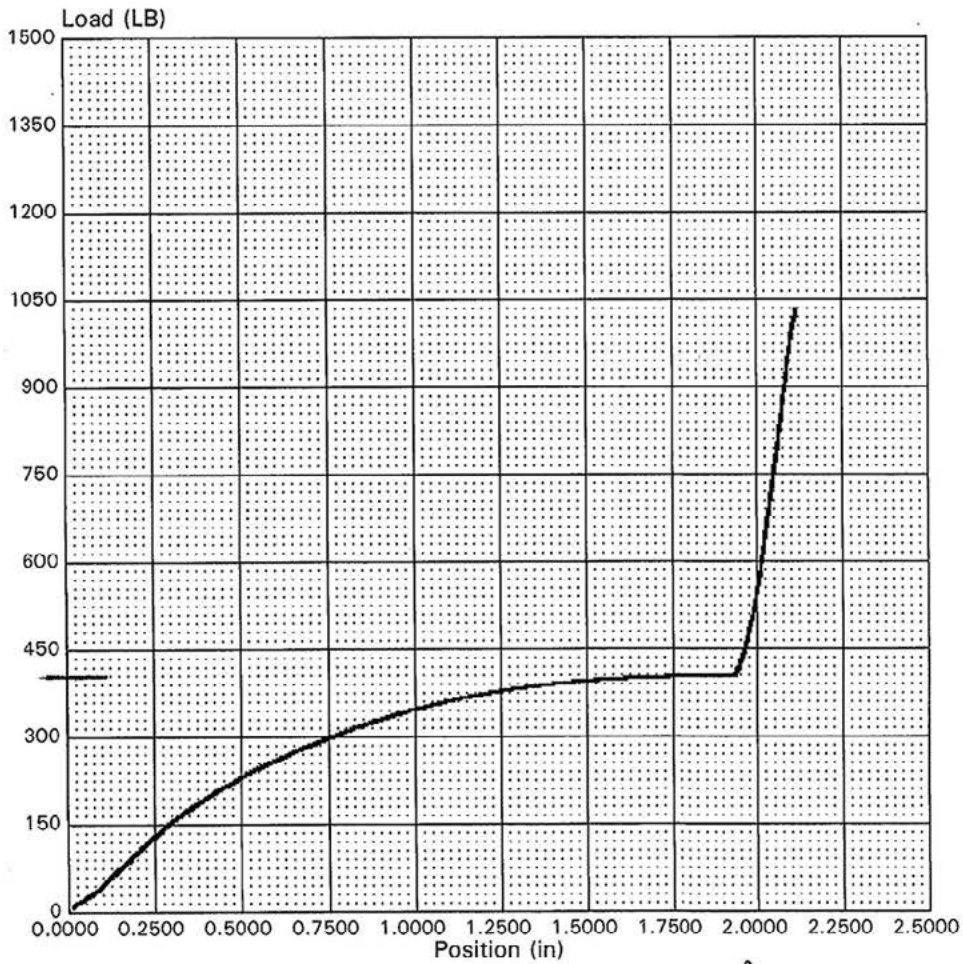

1-A

RESULTS

Initials: DS Date: 9/14/15
LAB EQUIPMENT USED
Compression Machine:
ELE S/N 07010000077 _____
ELE S/N 00-13 _____
SATEC S/N 400HVL1075 _____
United S/N 890212 X _____
Measurement:
Calliper S/N _____
Other:

All-tile Adjustable Hook
Uplift #1

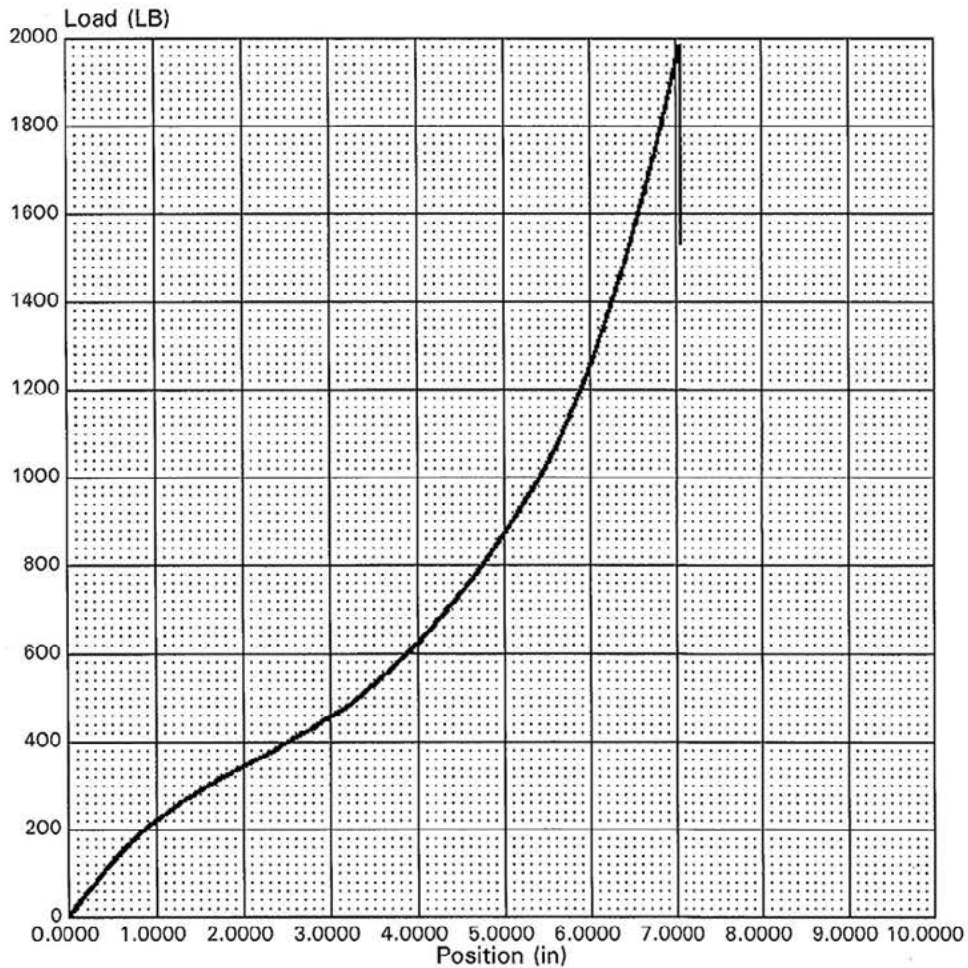

RESULTS

Initials: DS Date: 9/14/15
LAB EQUIPMENT USED
Compression Machine:
ELE S/N 07010000077 _____
ELE S/N 00-13 _____
SATEC S/N 400HVL1075 _____
United S/N 890212 X _____
Measurement:
Calliper S/N _____
Other:

All-tile Adjustable Hook
Uplift #2

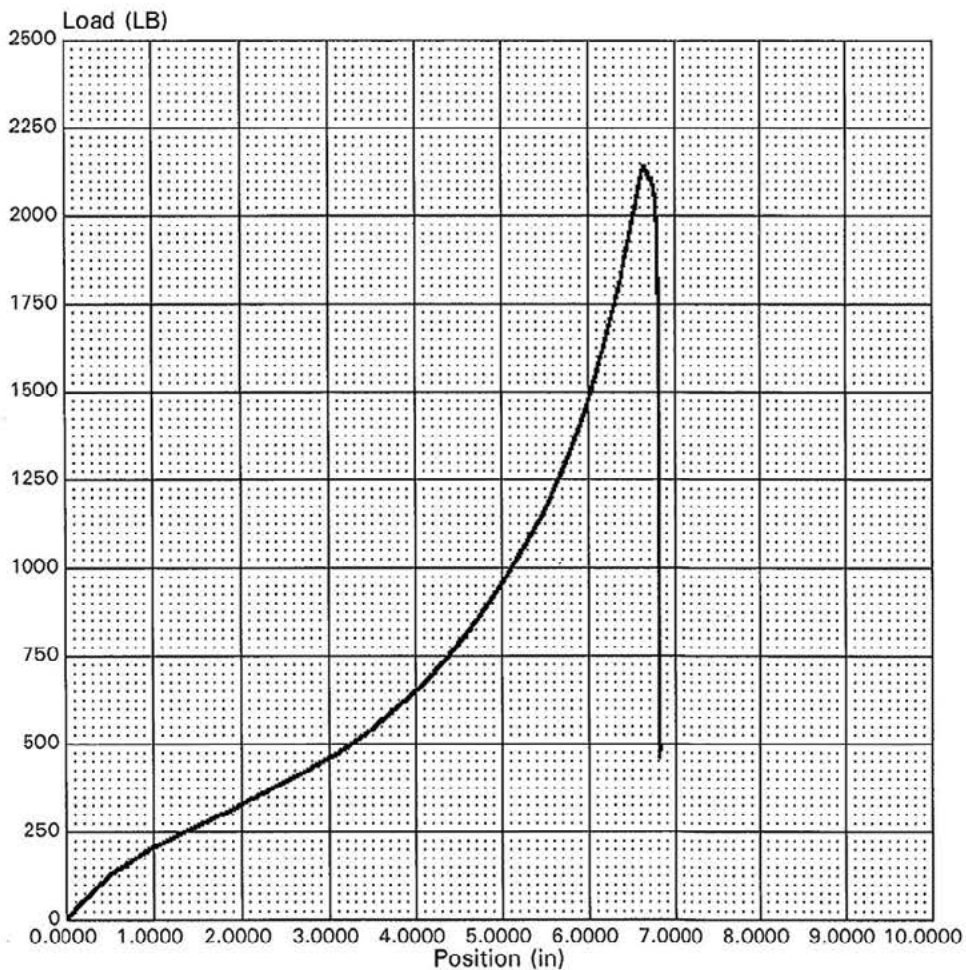

RESULTS

Initials: DS Date: 9/14/13
LAB EQUIPMENT USED
Compression Machine:
ELE S/N 07010000077 _____
ELE S/N 00-13 _____
SATEC S/N 400HVL1075 _____
United S/N 890212 X _____
Measurement:
Caliper S/N _____
Other:

All-tile Adjustable Hook
Uplift #3

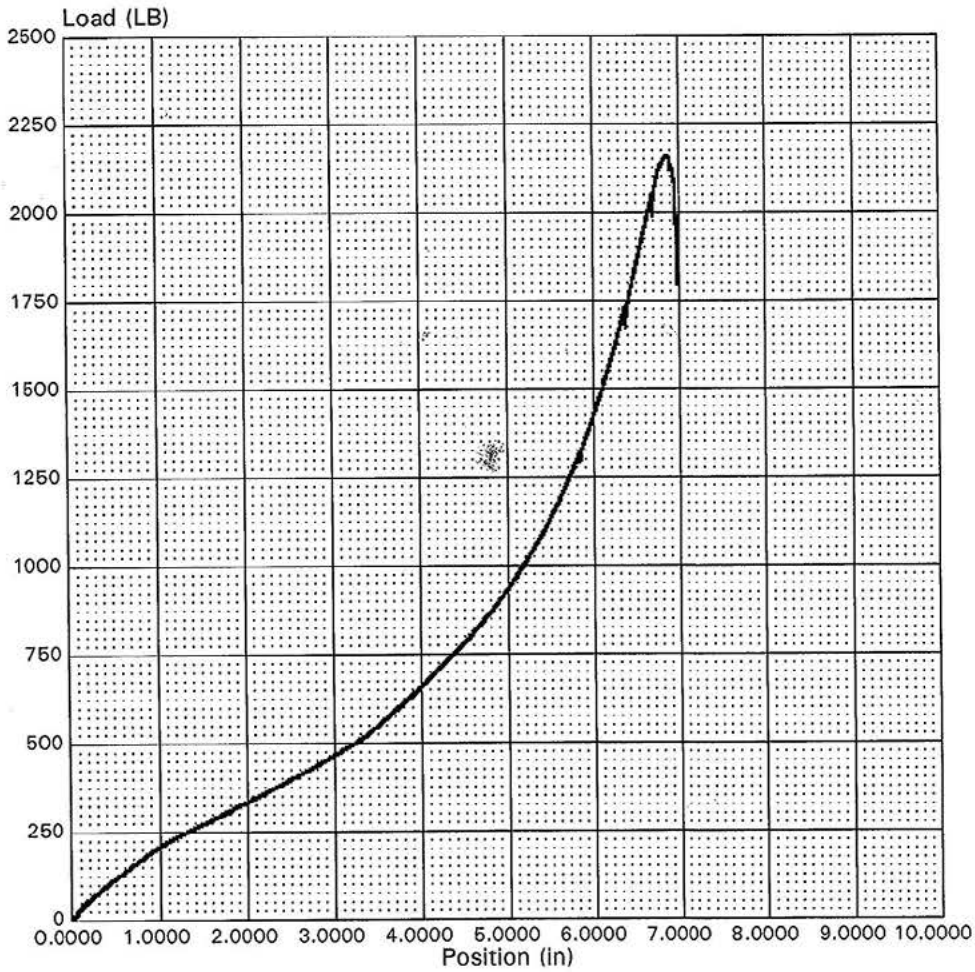

RESULTS

Initials: DS Date 9/14/15
LAB EQUIPMENT USED
Compression Machine:
ELE S/N 070100000077 _____
ELE S/N 00-13 _____
SATEC S/N 400HVL1075 _____
United S/N 890212 X _____
Measurement:
Caliper S/N _____
Other: _____

All-tile Adjustable Hook
Lateral #1

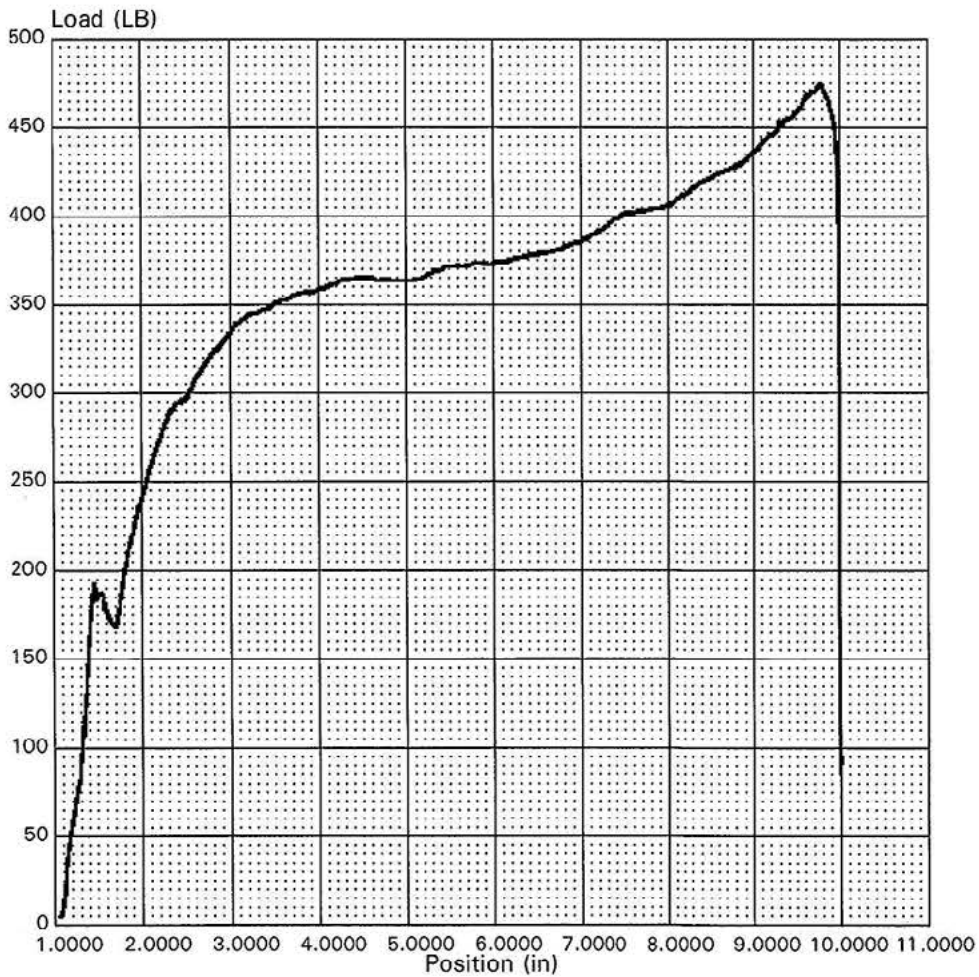

RESULTS

Initials: PS Date: 9/16/15
LAB EQUIPMENT USED
Compression Machine:
ELE S/N 070100000077 _____
ELE S/N 00-13 _____
SATEC S/N 400HVL1075 _____
United S/N 890212 ✓ _____
Measurement:
Caliper S/N _____
Other:

All-tile Adjustable Hook
Lateral #2

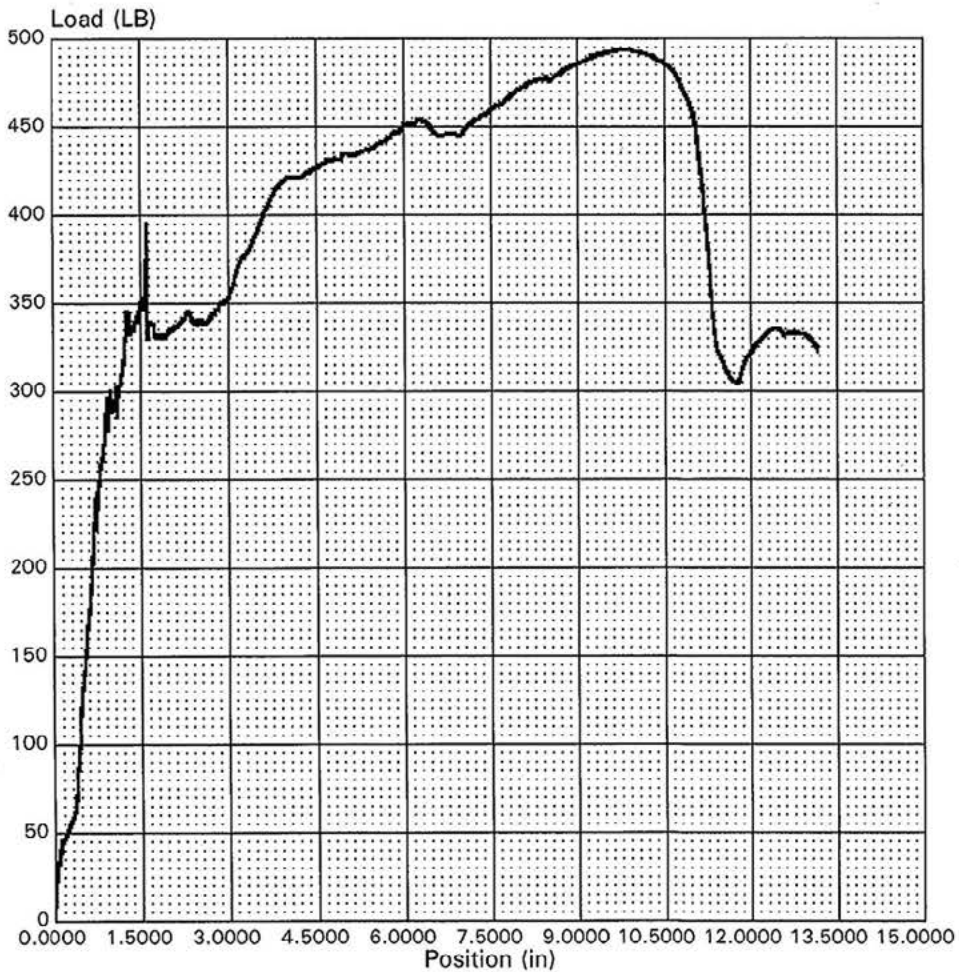

RESULTS

Initials: [Signature] Date: 9/17/15
LAB EQUIPMENT USED
Compression Machine:
ELE S/N 07010000077 _____
ELE S/N 00-13 _____
SATEC S/N 400HVL1075 _____
United S/N 890212 X _____
Measurement:
Calliper S/N _____
Other:

All-tile Adjustable Hook
Lateral #3

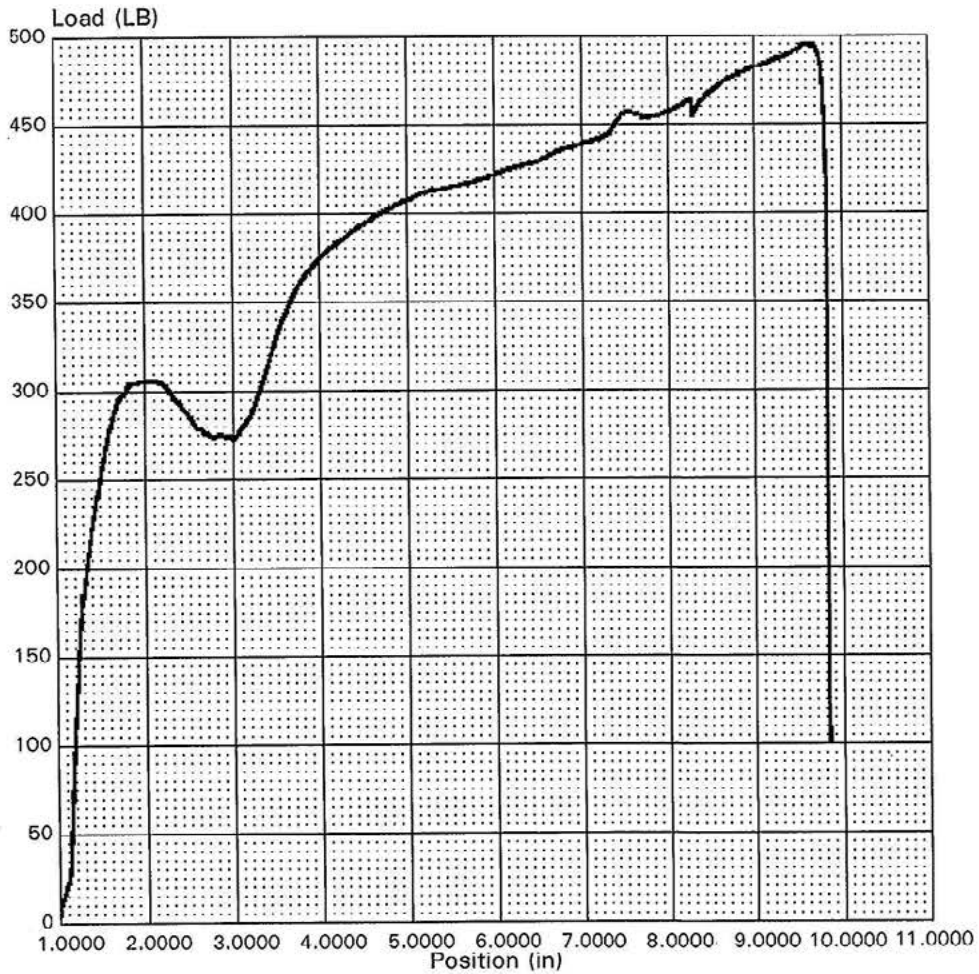

AZ TEST RESULTS

Mr. Rick Gentry
Quickscrews International
SolarRoofHook.com
5830 Las Positas Road
Livermore, CA 94551



Subject: Uplift, Compressive Load, and Lateral Load Test of QS #17541 (Kit #17543) 90° Flat Tile Roof Hook.

Dear Mr. Gentry,

Per our service agreement, PNL has tested the 90° Flat Tile Roof Hook. The tests performed were a tensile load (uplift) test, compressive load test, and shear load (lateral load) test. A total of two roof hooks were tested for each load type. The samples submitted were the roof hook and screws from Kit #17543. The submitted sample materials are the same roof hook and screws in Part #17540, #17541, and Kit #17542.

INITIAL SETUP

Each roof hook was attached to a Douglas Fir 2"x4" using two #14 x 3" Solar Mounting Screws. The 2"x4" rafter and plywood test fixtures were assembled in our laboratory by using 5/16" x 3-1/8" RSS Rugged Structural screws to connect three 12 in. long 2"x4" douglas fir rafters to the 12 mm Birch plywood. Each 2"x4" rafter was connected to the plywood using two screws at each end of the 12 in. long 2"x4" (See Page 6 for photos and details).

TEST PROCEDURE

Tensile Load (Uplift) Test

A total of two tests were conducted for tensile load (uplift) capacity on an Instron Universal Test Machine (UTM). The test samples were rigidly attached to the test machine using clamps and a tensile load was applied to the roof hook. The tensile load was applied at a constant rate of 0.09 in./min. without shock until failure. The load and displacement at failure were recorded and the failure mode was documented in photos. The average tensile load of the 90° Flat Tile Roof Hook attached to the 2"x4" using the #14 x 3" Solar Mounting screws was 1507 lbf. Additional details and photographs are supplied on page 3.

Compressive Load Test

A total of two tests were conducted for compressive load capacity on a UTM. The test samples were rigidly attached to the test machine using clamps and a compressive load was applied to the roof hook. The compressive load was applied at a constant rate of 0.09 in./min. without shock until the roof hook came into contact with the plywood base. The load and displacement at contact were

recorded and the failure mode was documented in photos. The average compressive load of the 90° All Tile Roof Hook with Slots and 8 mm Height Adjustment Range attached to the 2"x4" using the #14 x 3" Solar Mounting screws was 340 lbf. Additional details and photographs are supplied on page 4.

Shear Load (Lateral Load) Test

A total of two tests were conducted for shear load (lateral load) capacity on a UTM. The test samples were rigidly attached to the test machine using clamps so that a compressive load could be applied to the roof hook in a direction parallel to the 2"x4" rafters. The shear load was applied at a constant rate of 0.09 in./min. without shock until the roof hook until failure. The load and displacement at tact were recorded and the failure mode was documented in photos. The average compressive load of the 90° All Tile Roof Hook with Slots 8 mm Height Adjustment Range attached to the 2"x4" using the #14 x 3" Solar Mounting screws was 420 lbf. Additional details and photographs are supplied on page 5.

Respectfully Submitted,
PHOENIX NATIONAL LABORATORIES, INC.



Kyle Fleege, P.E.
Project Manager
PNL
Ph: 602.431.8887
kyle@pnltest.com
www.pnltest.com





Phoenix National Laboratories, Inc.
 2037 E. Chambers Street, Phoenix, AZ 85040
 P: 602.431.8887 · F: 602.431.8889 · www.pnltest.com

LABORATORY TEST REPORT

UPLIFT LOAD (TENSILE)

90° All Tile Roof Hook with Slots
 w/ 9 mm x 18 mm mounting screw slots

CLIENT		CLIENT PROJECT REF. NO.		CLIENT ORDER NO.	
SolarRoofHook		17585, 17586, 17589, 17618		Per S.A.	
SAMPLE DESCRIPTION			ROOF HOOK ID		PRODUCT KIT ID
90° All Tile Roof Hook w/ Slots, 8 mm Height Adj.			17585, 17586		17589, 17618
MATERIAL SUBMITTED BY	PNL PROJECT NO.	S.O. NO.	PNL LAB NO.	REPORT DATE	
Client	26-170169	001	ML827507	04/18/2017	
TEST SPECIFICATIONS & EQUIPMENT INFORMATION					
TEMPERATURE:	73° ± 3°F		HUMIDITY:	50 ± 5%	
EQUIPMENT MODEL:	Instron 5985		SERIAL NO:	5985U1246	
LOAD CELL:	50 kN (11,240 lbf)		SERIAL NO:	122570	
TEST SPEED:	0.09 in./min.		FASTENER TYPE:	#14 x 3" Solar Mounting Screws	
FASTENER LOCATION:	Fasteners (Qty 2) installed in furthest slot point and secured to 2 x 4 running underneath plywood.				
TENSILE LOAD (UPLIFT) TEST DATA					
NO.	MAXIMUM LOAD (lbf)	DISPLACEMENT AT LOAD (in.)	OBSERVATIONS		
1	1179.7	5.691	Fastener pullout and permanent deformation failure.		
2	1598.9	6.737	Fastener pullout and permanent deformation failure.		
AVG.	1389.3	6.214			

PHOTOS



Photo 1: Tensile Test Setup



Photo 2: Tensile Test Setup



Photo 3: Typical Failure Mode - Fastener Pullout



Photo 4: Closeup of Fastener Pullout & Failure



Phoenix National Laboratories, Inc.
 2837 E. Chambers Street, Phoenix, AZ 85040
 P: 602.431.8887 · F: 602.431.8889 · www.pnltest.com

LABORATORY TEST REPORT COMPRESSION LOAD

90° All Tile Roof Hook with Slots
 w/ 9 mm x 18 mm mounting screw slots

CLIENT		CLIENT PROJECT REF. NO.		CLIENT ORDER NO.	
SolarRoofHook		17585, 17586, 17589, 17618		Per S.A.	
SAMPLE DESCRIPTION			ROOF HOOK ID		PRODUCT KIT ID
90° All Tile Roof Hook w/ Slots, 8 mm Height Adj.			17585, 17586		17589, 17618
MATERIAL SUBMITTED BY		PNL PROJECT NO.	S.O. NO.	PNL LAB NO.	REPORT DATE
Client		26-170169	001	ML827507	04/18/2017
TEST SPECIFICATIONS & EQUIPMENT INFORMATION					
TEMPERATURE:		73° ± 3°F		HUMIDITY:	
				50 ± 5%	
EQUIPMENT MODEL:		Instron 5985		SERIAL NO:	
				5985U1246	
LOAD CELL:		10 kN (2,248 lbf)		SERIAL NO:	
				204786	
TEST SPEED:		0.09 in./min.		FASTENER TYPE:	
				#14 x 3" Solar Mounting Screws	
FASTENER LOCATION:		Fasteners (Qty 2) installed in furthest slot point and secured to 2 x 4 running underneath plywood.			
COMPRESSION LOAD TEST DATA					
NO.	MAXIMUM LOAD (lbf)	DISPLACEMENT AT LOAD (in.)	OBSERVATIONS		
3	340.4	2.118	Test Hook permanently deformed and came into contact with plywood base.		
4	339.6	2.156	Test Hook permanently deformed and came into contact with plywood base.		
AVG.	340.0	2.137			

PHOTOS



Photo 5: Compression Test Setup



Photo 6: Compression Test Setup



Photo 7: Hook Contact with Plywood



Photo 8: Typical Failure - Contact with Plywood



Phoenix National Laboratories, Inc.
 2837 E. Chambers Street, Phoenix, AZ 85040
 P: 602.431.8887 · F: 602.431.8889 · www.pnltest.com

LABORATORY TEST REPORT SHEAR (LATERAL) LOAD

90° All Tile Roof Hook with Slots
 w/ 9 mm x 18 mm mounting screw slots

CLIENT		CLIENT PROJECT REF. NO.		CLIENT ORDER NO.	
SolarRoofHook		17585, 17586, 17589, 17618		Per S.A.	
SAMPLE DESCRIPTION			ROOF HOOK ID		PRODUCT KIT ID
90° All Tile Roof Hook w/ Slots, 8 mm Height Adj.			17585, 17586		17589, 17618
MATERIAL SUBMITTED BY	PNL PROJECT NO.	S.O. NO.	PNL LAB NO.	REPORT DATE	
Client	26-170169	001	ML827507	04/18/2017	
TEST SPECIFICATIONS & EQUIPMENT INFORMATION					
TEMPERATURE:	73° ± 3°F		HUMIDITY:	50 ± 5%	
EQUIPMENT MODEL:	Instron 5985		SERIAL NO:	5985U1246	
LOAD CELL:	10 kN (2,248 lbf)		SERIAL NO:	204786	
TEST SPEED:	0.09 in./min.		FASTENER TYPE:	#14 x 3" Solar Mounting Screws	
FASTENER LOCATION:	Fasteners (Qty 2) installed in furthest slot point and secured to 2 x 4 running underneath plywood.				
SHEAR LOAD TEST DATA					
NO.	MAXIMUM LOAD (lbf)	DISPLACEMENT AT LOAD (in.)	OBSERVATIONS		
5	430.5	6.798	Permanent deformation of roof hook and screws. 1 screw head sheared off.		
6	409.8	8.097	Permanent deformation of roof hook and screws. Both screws intact.		
AVG.	420.2	7.448			

PHOTOS



Photo 9: Shear Test Setup



Photo 10: Shear Test Setup



Photo 11: Deformation and Rotation of Hook



Photo 12: Failure of Screw Head



Phoenix National Laboratories, Inc.
 2837 E. Chambers Street, Phoenix, AZ 85040
 P: 602.431.8887 · F: 602.431.8889 · www.pnltest.com

LABORATORY TEST REPORT

CLIENT	CLIENT PROJECT REF. NO.	CLIENT ORDER NO.		
SolarRoofHook	17585, 17586, 17589, 17618	Per S.A.		
SAMPLE DESCRIPTION	ROOF HOOK ID	PRODUCT KIT ID		
90° All Tile Roof Hook w/ Slots, 8 mm Height Adj.	17585, 17586	17589, 17618		
MATERIAL SUBMITTED BY	PNL PROJECT NO.	S.O. NO.	PNL LAB NO.	REPORT DATE
Client	26-170169	001	ML827507	04/18/2017

TEST MOCKUP CONFIGURATION

The base for the test assemblies was made from three 12 in. long Douglas Fir 2"x4"s screwed to 12 mm Birch plywood using 5/16" x 3-1/8" RSS Rugged Structural screws. The Roof Hooks were then attached using two of the Client provided #14 x 3" Solar Mounting Screws. On roof hooks that had multiple mounting screw slots, the screws were set at the furthest end of the furthest slot from the 90° section of the roof hook. The mounting screws were screwed through the plywood and into a 2"x4" underneath. On adjustable roof hooks, the 90° roof hook attachment was connected at one extreme end and the mounting screws were attached in screw slots at the opposite end.

PHOTOS



Photo 13: Test Mockup Base Assembly



Photo 14: Fasteners for Plywood to 2x4: 5/16 x 3-1/8" RSS Rugged Structural Screws



Photo 15: Douglas Fir 2x4 Product Tag



Photo 16: Birch Plywood Product Tag