

17574

17575, 17576, 17577

CURVED TILE ROOF HOOK FOR SIDE MOUNT RAILS; ADJUSTABLE WIDE BASE



A DIVISION OF QUICKSCREWS INTERNATIONAL CORP

TABLE OF CONTENTS

3

SPEC SHEET

QTY & MEASUREMENT INFORMATION

4

UL CERTIFICATION

PROOF OF UL CERTIFICATION

6

INSTALLATION INSTRUCTIONS

STEP-BY-STEP-INSTALLATION GUIDE

7

BUILDING CODE LETTER

REGARDING STAMP DATES

8

ENGINEERING REPORT

UPLIFT & LATERAL LOAD TEST

SPEC SHEET

Part #	Box Quantity	Screw Size
17574	10 Hooks	N/A
17575	1 Hook	N/A
17576	10 Hooks; 20 Screws	5/16" x 3"
17577	1 Hook; 2 Screws	5/16" x 3"

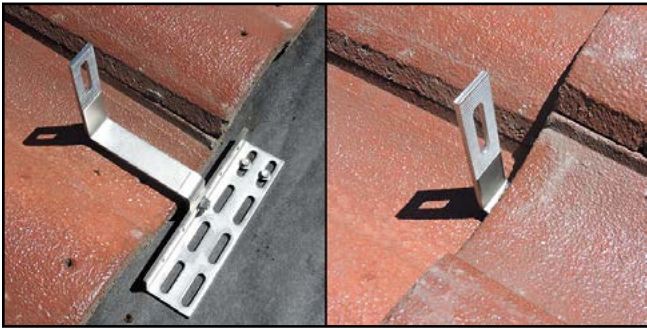

Letter	Description	Size/Length
A	Mounting Screw Slot	9mm x 37mm
B	Rail Slot Size	10mm x 46mm
C	Length of Roof Hook	180.50mm
D	Bottom End to Top End	178mm
E	Thickness	6mm
F	Adjustability Range	42mm - 50mm

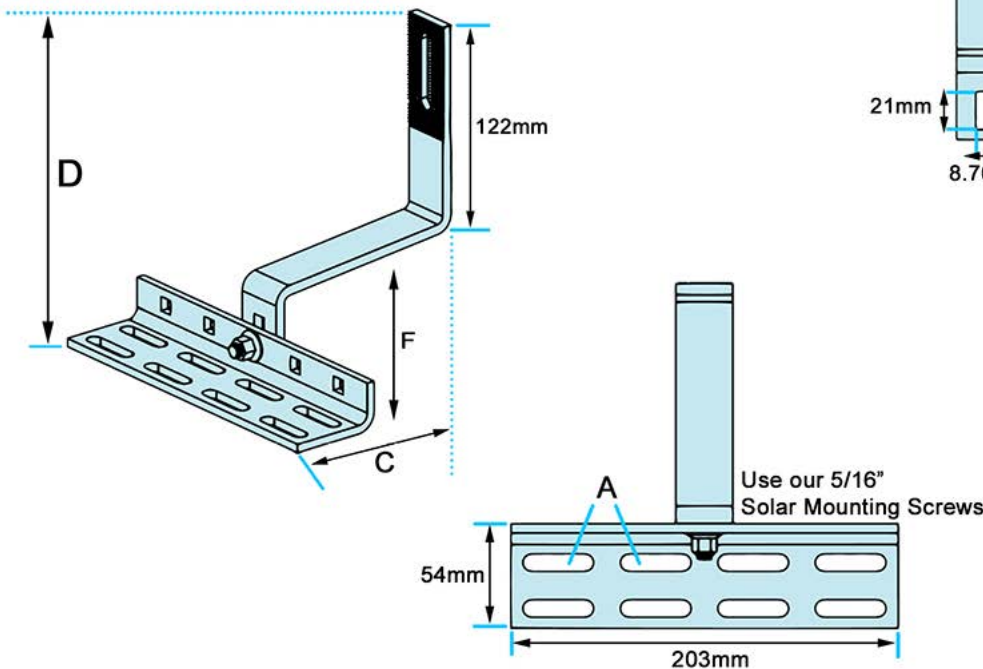
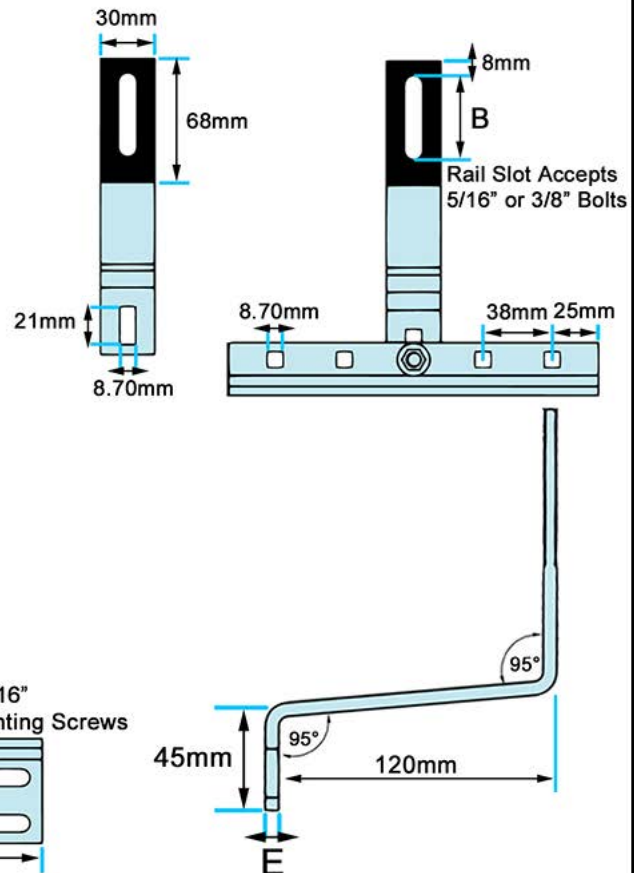

CERTIFICATE OF COMPLIANCE

Certificate Number E493748
Report Reference E493748-20170817
Date 2023-April-07

Issued to: QuickBOLT a Division of Quickscrews International Corp
5830 Las Positas Rd
Livermore CA, 94551 US

This is to certify that representative samples of MOUNTING SYSTEMS, MOUNTING DEVICES, CLAMPING DEVICES AND GROUND LUGS FOR USE WITH PHOTOVOLTAIC MODULES AND PANELS - COMPONENT
See Addendum Page for Product Designation(s).

Have been evaluated by UL in accordance with the component requirements in the Standard(s) indicated on this Certificate. UL Recognized components are incomplete in certain constructional features or restricted in performance capabilities and are intended for installation in complete equipment submitted for investigation to UL LLC.

Standard(s) for Safety: UL 2703, Mounting systems, mounting devices, clamping/retention devices, and ground lugs for use with flat-plate photovoltaic modules and panels-.

Additional Information: See the UL Online Certifications Directory at <https://iq.ulprospector.com> for additional information

This Certificate of Compliance indicates that representative samples of the product described in the certification report have met the requirements for UL certification. It does not provide authorization to apply the UL Recognized Component Mark. Only the Authorization Page that references the Follow-Up Services Procedure for ongoing surveillance provides authorization to apply the UL Mark.

Only those products bearing the UL Recognized Component Mark should be considered as being UL Certified and covered under UL's Follow-Up Services.

Look for the UL Recognized Component Mark on the product.

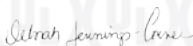

Deborah Jennings-Conner, VP Regulatory Services

UL LLC

Any information and documentation involving UL Mark services are provided on behalf of UL LLC (UL) or any authorized licensee of UL. For questions, please contact a local UL Customer Service Representative at <http://ul.com/about/locations/>



CERTIFICATE OF COMPLIANCE

Certificate Number E493748
Report Reference E493748-20170817
Date 2023-April-07

This is to certify that representative samples of the product as specified on this certificate were tested according to the current UL requirements

Models:

USR – Component, Roof Mounting Hook Units, Models 15891 15893 15987 16000 16317 16318
16319 16320 16988 16990 16991 16993 17508 17509 17510 17511 17512 17513 17514 17515
17516 17517 17518 17519 17520 17521 17522 17523 17524 17525 17526 17527 17536 17537
17538 17539 17540 17541 17542 17543 17544 17545 17546 17547 17548 17549 17550 17551
17552 17553 17554 17555 17556 17558 17559 17560 17566 17567 17568 17569 17570 17571
17572 17573 17574 17575 17576 17577 17578 17579 17580 17585 17586 17587 17588 17589
17592 17596 17597 17598 17599 17600 17601 17606 17607 17608 17609 17610 17611 17612
17613 17614 17615 17616 17617 17618 17620 17621 17622 17623 17624 17625 17626 17627
17628 17629 17630 17631 17632 17633 17636 17637 17638 17639 17640 17641 17642 17643
17646 17647 17648 17649 17650 17651 17652 17653 17654 17659 17664 17667 17669 17670
17671 17672 17673 17678 17679 17680 17681 17686 17687 17688 17689 17700 17701 17702
17703 17704 17705 17706 17707 17708 17709 17710 17711 17712 17717 17718 17750 17751
17752 17753 17759 15891-10 15891BLK-10 15987A 15987B 17667SS 17672SS 17680SS
17688SS 17713SS 17720 17721SS 17723 17724SS 17726 17727SS 17729 17730SS 15894SS
15891SS 15987BSS 17660 17661 17662 17663 17747 17748

Deborah Jennings-Conner

Deborah Jennings-Conner, VP Regulatory Services

UL LLC

Any information and documentation involving UL Mark services are provided on behalf of UL LLC (UL) or any authorized licensee of UL. For questions, please contact a local UL Customer Service Representative at <http://ul.com/about/locations/>



INSTALL INSTRUCTIONS



1

RECOMMENDED MATERIALS

- Rafter locator
- Chalk or crayon
- Drill Bit
- Manufacturer's approved sealant



2

INSTALLATION INSTRUCTIONS

1. Remove the tiles from the install area
2. Locate and mark the rafters
3. Place the mount and predrill holes
4. Fill the predrilled holes with mfg. approved sealant
5. Drive the Mounting Screws
6. Place the tiles back over the roof mount



3

TORQUE REQUIREMENTS

M8 Bolt requires 18 minimum torque ft-lb



4

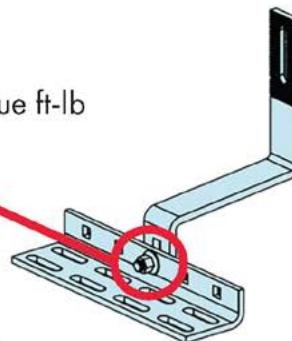

5

IF USING GALVA FLASHING

1. Make a cut in the paper
2. Apply sealant to the underside of the Galva Flashing
3. Slide the Flashing underneath the paper or nail down edges
4. Cover the edges of the Galva Flashing with sealant



6



PN 15890



BUILDING CODE LETTER



March 22nd, 2023

To whom this may concern,

QuickBOLT is committed to excellence. The parts tested are durable goods, meaning the material composition and detailed specifications of the parts do not change. Therefore, all stamps are current. Any part tested will have the same results no matter what year the tests are performed. All testing and reports are current and valid with 2022 CBC standards.

SolarRoofHook is the previous name of QuickBOLT. Any test result referencing SolarRoofHook is referring to a QuickBOLT product.

All our parts were tested by a third-party test facility, in possession of a current engineering license for the state where the tests were performed for the following.

1. Uplift test
2. Downward load test
3. Lateral Test – Asphalt Mounts, and Metal Mounts only
4. ASTM E2440 and ASTM E330 Waterproof Tests - QuickBOLT only

The following is an excerpt from:

CALIFORNIA BOARD FOR PROFESSIONAL ENGINEERS AND LAND SURVEYORS
guide to Engineering & Land Surveying for City and County Officials
Page 12, Line 27

27. If the license has expired between the time the engineering documents were prepared and the time when the local agency's review is performed, do the documents need to be re-sealed by a licensee with a current license? (B&P Code §§ 6733, 6735, 6735.3, 6735.4)

As long as the license was current at the time the engineering documents were prepared, the documents do not need to be re-sealed prior to review by the local agency. However, any changes (updates or modifications) to the documents that are made following the review by the local agency would have to be prepared by a licensed engineer with a current license and those changes would have to be signed and sealed.

We trust the information provided will resolve any request for the test reports submitted to have a stamp from the current year.

Regards,

Rick Gentry
Executive Vice President

ENGINEERING REPORT



APPLIED MATERIALS & ENGINEERING, INC.

980 41st Street
Oakland, CA 94608

Tel: (510) 420-8190
FAX: (510) 420-8186
e-mail: info@appmateng.com

June 11, 2015

Mr. Rick Gentry

SolarRoofHook

a division of Quickscrew International Corp.
5830 Las Positas Road
Livermore, CA 94551

Project Number 115377C

Subject: QS# 17575 –All Tile Wide Roof Hook 90° Laboratory Load Testing

Dear Mr. Gentry:

As requested, Applied Materials & Engineering, Inc. (AME) has completed load-testing the All Tile Wide Roof Hook 90° (see Appendix A, Figure 1). The purpose of our testing was to evaluate the compressive and tensile (uplift) load capacity of the All Tile Wide Roof Hook 90° (part # 17574, 17575, 17576 & 17577) attached to a 2"x4" Douglas Fir Rafter using two 5/16"Øx3" screws (part # 16988, 16989 & 16990).

SAMPLE DESCRIPTION

Mockup samples were assembled in our laboratory on June 8th, 2015. Mockup configuration consisted of three 16" long rafters at 4.5"o.c., screwed to 1/2" Structural I plywood. All Tile Wide Roof Hook 90° is attached through the plywood into a rafter with two fasteners installed at the farthest end.

TEST PROCEDURES & RESULTS

1. Compressive Load Test

A total of three tests were conducted for compressive load capacity on June 8th, 2015 using a United Universal testing machine. Samples were rigidly attached to the testing machine and a compressive load was applied to the hook. The samples were loaded in compression at a constant rate of axial deformation of 0.09 in./min. without shock until the hook was bent and came in contact with the test board; displacement at maximum load was recorded. Based on the above testing, the average maximum compression load of the All Tile Wide Roof Hook 90° attached to a 2"x4" Douglas Fir rafter using two 5/16"Øx3" screws was determined to be 311 lbf. Detailed results are provided in Table I. Test setup and mode of failure are provided in Appendix B, Figure 1.

The specific gravity and moisture content of the rafter was tested in accordance with ASTM D2395, Method A (oven-dry). The specific gravity and moisture content were determined to be 0.404 and 12.0%, respectively.

Mr. Rick Gentry
QUICKSCREWS INTERNATIONAL
5830 Las Positas Road
Livermore, CA 94551

Project Number 115377C

2. Tensile (Uplift) Load Test

A total of three tests were conducted for compressive load capacity on June 8th, 2015 using a United Universal testing machine. Samples were rigidly attached to the testing machine and an uplift load was applied to the hook. The samples were loaded in tension at a constant rate of axial deformation of 0.09 in. /min. without shock until failure occurred; displacement at maximum load was recorded. Based on the above testing, the average maximum uplift load of the All Tile Wide Roof Hook 90° attached to a 2"x4" Douglas Fir rafter using two 5/16"Øx3" screws was determined to be 2836 lbf. Detailed results are provided in Table II. Test setup and mode of failure are provided in Appendix B, Figure 2.

The specific gravity and moisture content of the rafter was tested in accordance with ASTM D2395, Method A (oven-dry). The specific gravity and moisture content were determined to be 0.403 and 12.9%, respectively.

Respectfully Submitted,

APPLIED MATERIALS & ENGINEERING, INC.

Reviewed By:

Mohammed Faiyaz
Laboratory Manager





Armen Tajirian, Ph.D., P.E.
Principal

TABLE I
COMPRESSIVE LOAD TEST RESULTS
ALL TILE WIDE ROOF HOOK 90° (QS# 17575)
PROJECT NUMBER 115377C

SAMPLE ID	MAXIMUM COMPRESSIVE LOAD (lbf)	DISPLACEMENT AT MAXIMUM LOAD (in.)	FAILURE MODE
C-1	300	1.9	Hook contact w/Plywood
C-2	306	2.0	Hook contact w/Plywood
C-3	326	2.0	Hook contact w/Plywood
AVERAGE	311	2.0	..

TABLE II
TENSILE (UPLIFT) LOAD TEST RESULTS
ALL TILE WIDE ROOF HOOK 90° (QS# 17575)
PROJECT NUMBER 115377C

SAMPLE ID	MAXIMUM TENSILE LOAD (lbf)	DISPLACEMENT AT MAXIMUM LOAD (in.)	FAILURE MODE
T-1	2887	9.1	Fastener pullout
T-2	2726	9.0	Fastener pullout
T-3	2896	9.3	Fastener pullout
AVERAGE	2836	9.1	..

All Tile Wide 90
Compression #1

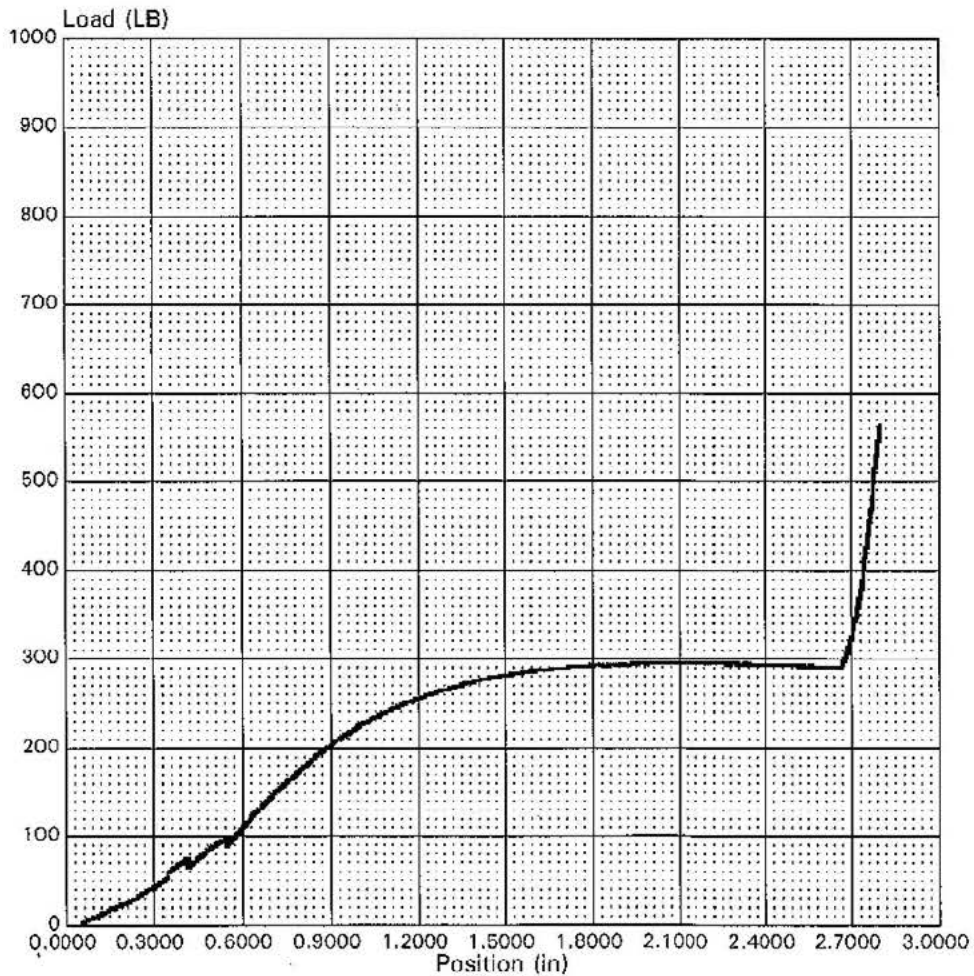

All Tile Wide 90
Compression #2

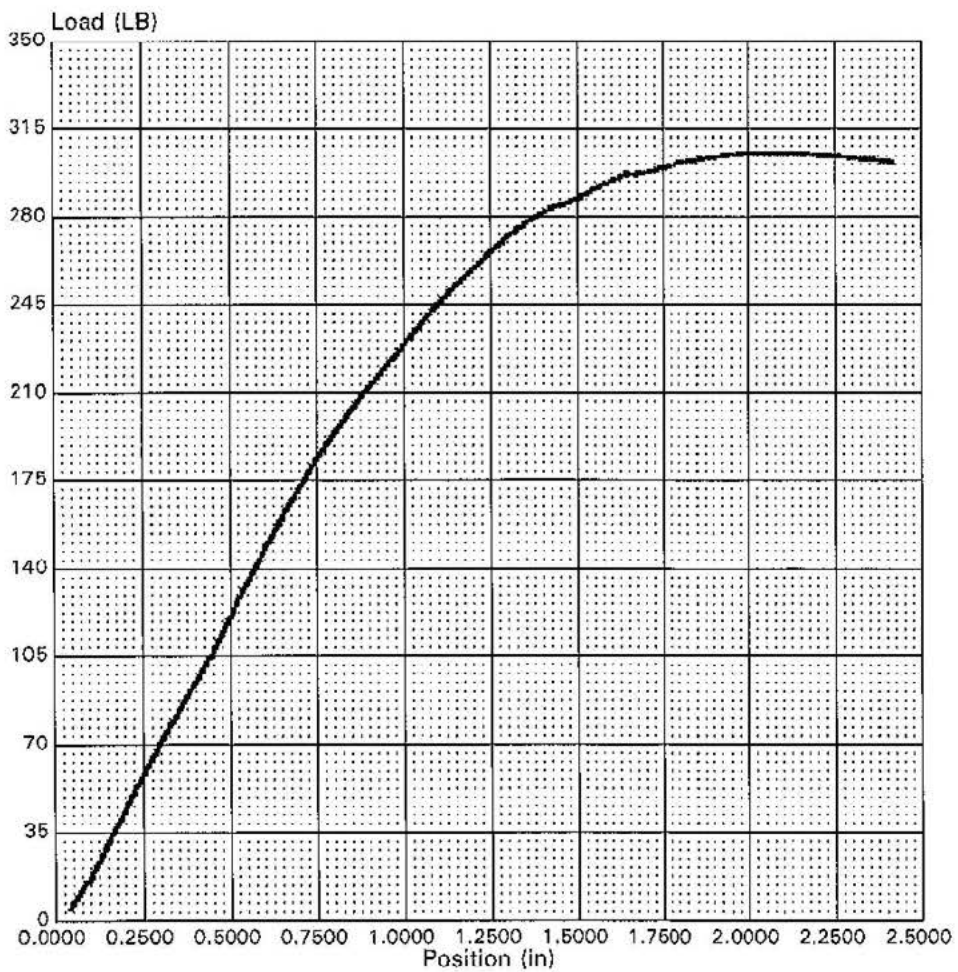

All Tile Wide 90
Compression #3

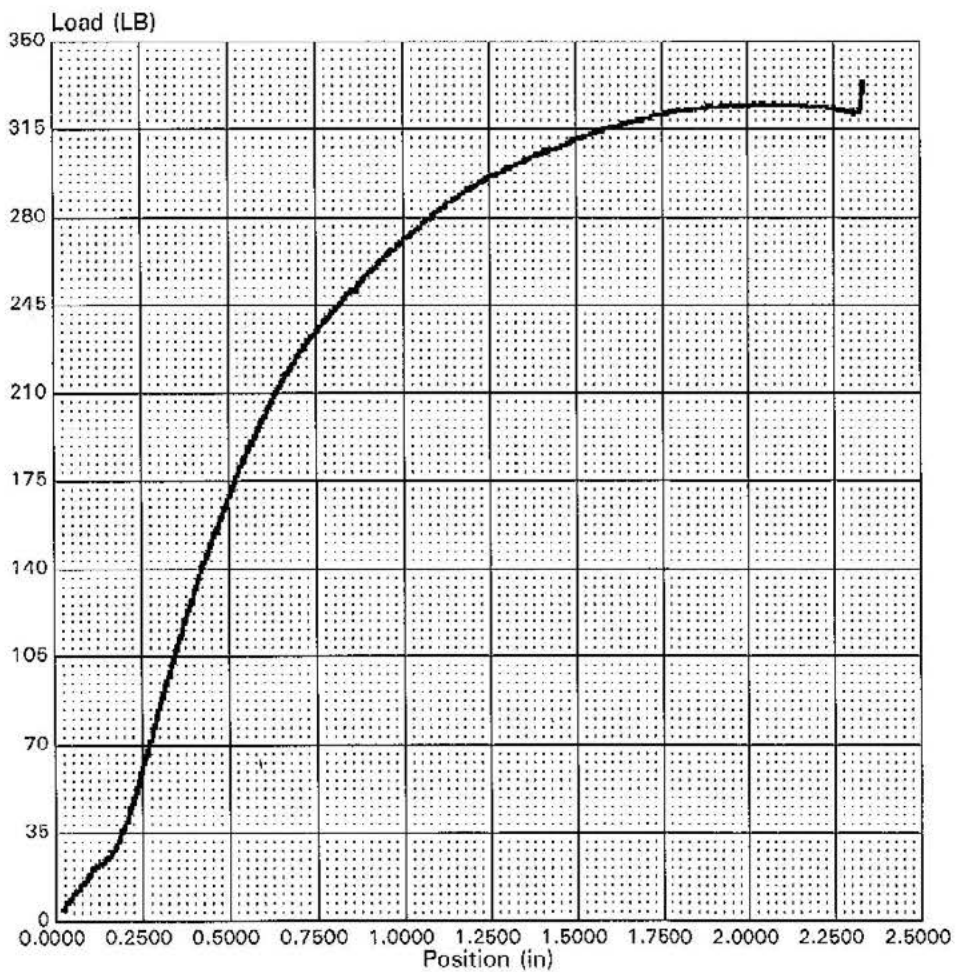

Initials: DS Date: 6/8/15
LAB EQUIPMENT USED
Compression Machine:
ELE S/N 07010000077 _____
ELE S/N 00-13 _____
SATEC S/N 400HVL1075 _____
United S/N 890212 X _____
Measurement:
Caliper S/N _____
Other:

All Tile Wide 90
Uplift #1

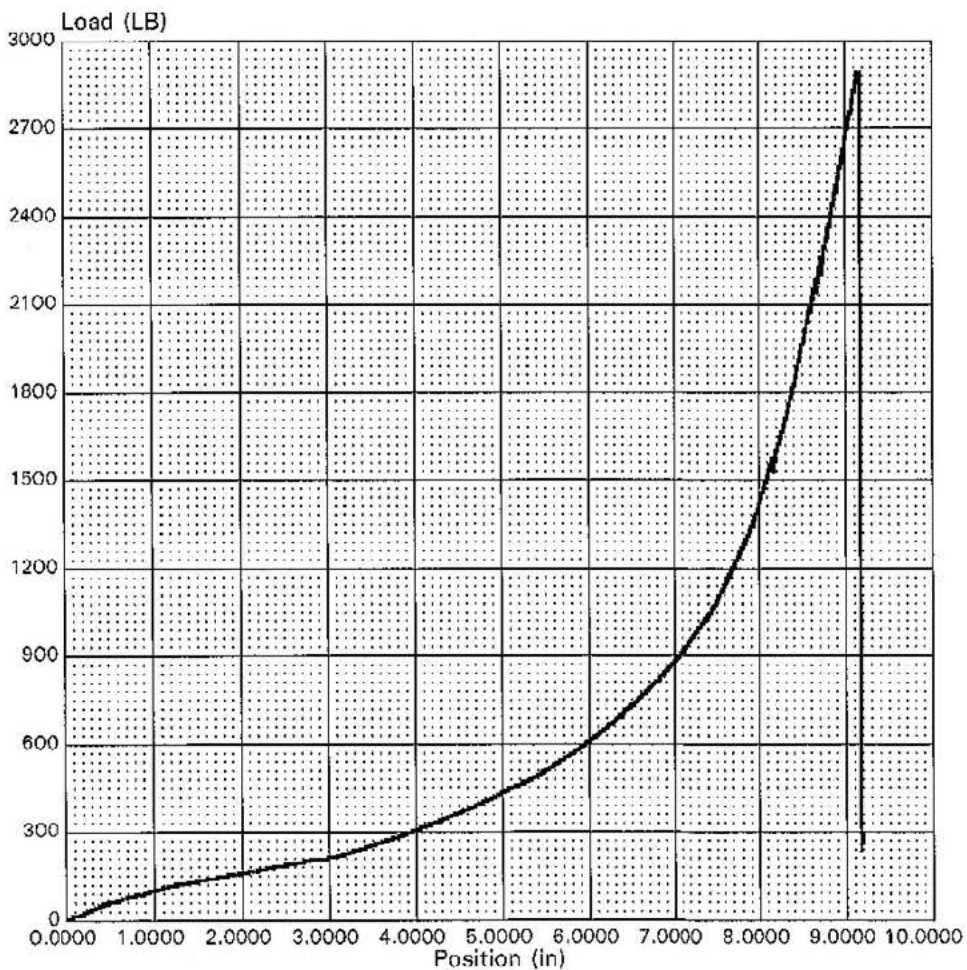

Initials: DS Date: 6/8/15
LAB EQUIPMENT USED
Compression Machine:
ELE S/N 07010000077 _____
ELE S/N 00-13 _____
SATEC S/N 400HVL1075 _____
United S/N 890212 X _____
Measurement:
Caliper S/N _____
Other:

All Tile Wide 90
Uplift #2

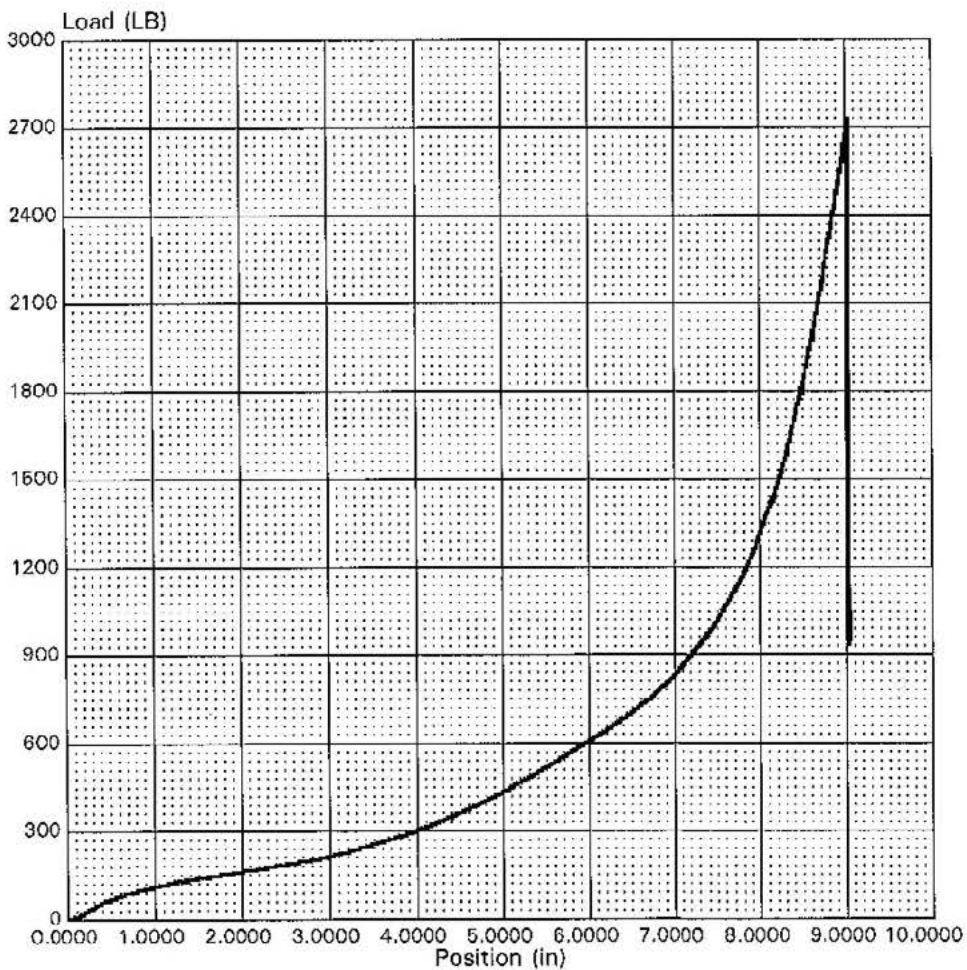

All Tile Wide 90
Uplift #3

