

# 16319

## BUTYL BOTTOM DECK MOUNT FOR ASPHALT, EPDM, & TPO ROOFS



A DIVISION OF QUICKSCREWS INTERNATIONAL CORP

# TABLE OF CONTENTS

3

## SPEC SHEET

QTY & MEASUREMENT INFORMATION

---

6

## UL CERTIFICATION

PROOF OF UL CERTIFICATION

---

8

## INSTALLATION INSTRUCTIONS

STEP-BY-STEP-INSTALLATION GUIDE

---

9

## BUILDING CODE LETTER

REGARDING STAMP DATES

---

10

## ENGINEERING REPORT #1

LOAD TESTING - DIRECT TO DECK

---

18

## ENGINEERING REPORT #2

LOAD TESTING - RAFTER MOUNTED

---

# SPEC SHEET

Part #	Box Quantity
16319	36 Mounts + 144 Screws w/ EPDM Washers



PN# 16319  
Screws

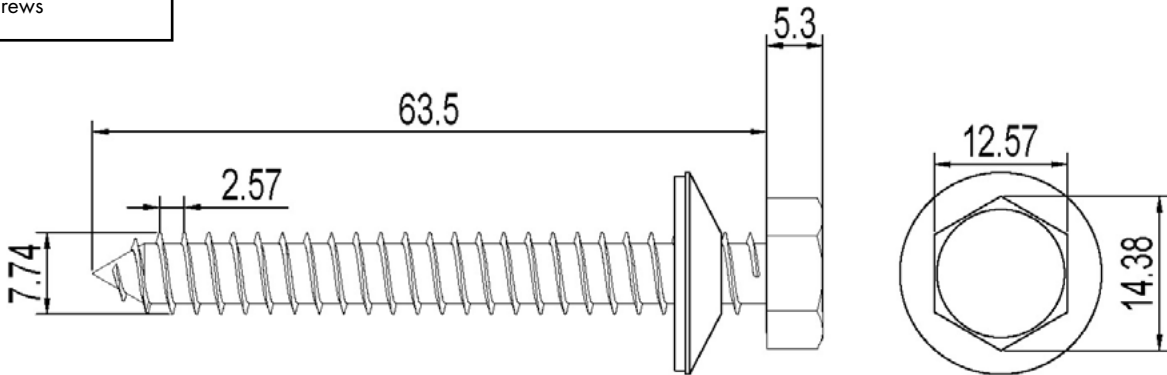

Tolerance Range		QuickBOLT											
Baiting tolerance	±2 mm		<table border="1"> <tr> <th>Scale</th> <th>Quantity</th> </tr> <tr> <td> </td> <td> </td> </tr> <tr> <th>Material</th> <td> </td> </tr> <tr> <th>Drawing No.</th> <td> </td> </tr> <tr> <th>Finish</th> <td> </td> </tr> </table>	Scale	Quantity			Material		Drawing No.		Finish	
Scale	Quantity												
Material													
Drawing No.													
Finish													
Hole tolerance	±0.3 mm												
Hole distance tolerance	±0.5 mm												
Form tolerance	±2 mm												
Thicknessness tolerance	±0.1 mm												
Angle tolerance	±1° mm	Verify											

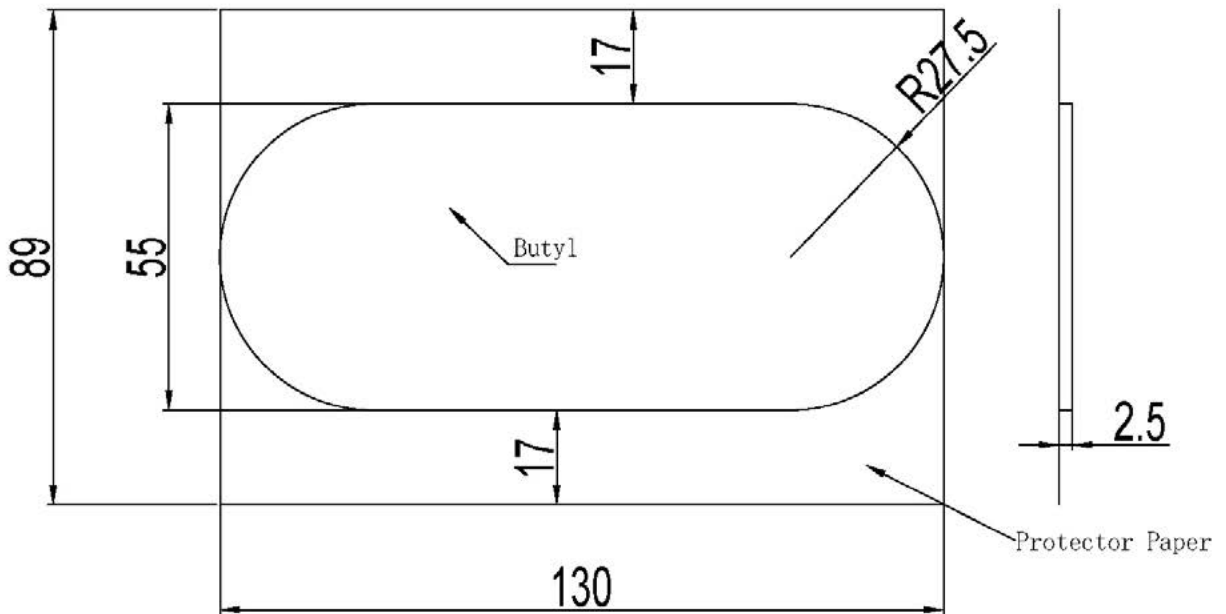

Tolerance Range		QuickBOLT											
Baiting tolerance	±2 mm		<table border="1"> <tr> <th>Scale</th> <th>Quantity</th> </tr> <tr> <td> </td> <td> </td> </tr> <tr> <th>Material</th> <td>EPDM</td> </tr> <tr> <th>Drawing No.</th> <td> </td> </tr> <tr> <th>Finish</th> <td> </td> </tr> </table>	Scale	Quantity			Material	EPDM	Drawing No.		Finish	
Scale	Quantity												
Material	EPDM												
Drawing No.													
Finish													
Hole tolerance	±0.3 mm												
Hole distance tolerance	±0.5 mm												
Form tolerance	±2 mm												
Thicknessness tolerance	±0.1 mm												
Angle tolerance	±1° mm	Verify											

PN# 16319  
Butyl backing

PN# 16319  
T-Foot

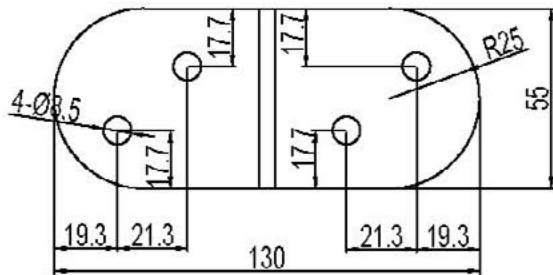
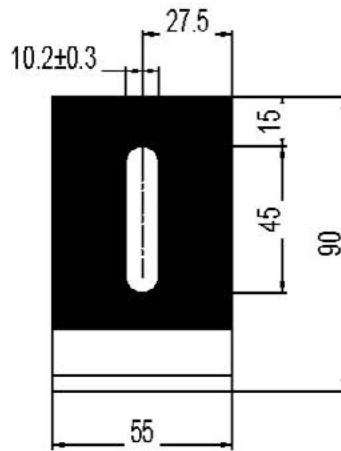
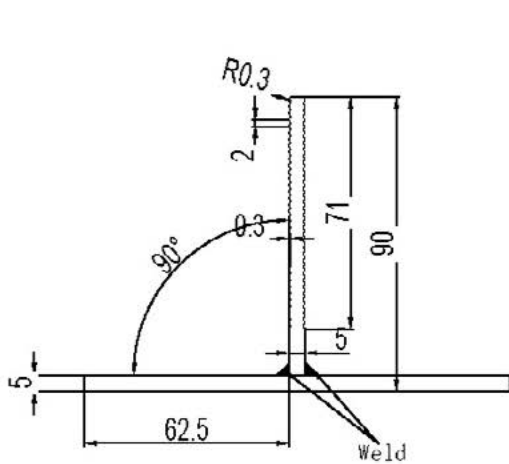

Tolerance Range						
Baiting tolerance	±2 mm					
Hole tolerance	±0.3 mm					
Hole distance tolerance	±0.5 mm	Design		Scale	Quantity	
Form tolerance	±2 mm	Drawing		Material	SUS304	
Thickness tolerance	±0.1 mm	Confirm		Drawing No.		
Angle tolerance	±1° mm	Verify		Finish		
			16319 & 16320			

## CERTIFICATE OF COMPLIANCE

**Certificate Number** E493748  
**Report Reference** E493748-20170817  
**Date** 2023-April-07

**Issued to:** QuickBOLT a Division of Quickscrews International Corp  
5830 Las Positas Rd  
Livermore CA, 94551 US

**This is to certify that representative samples of** MOUNTING SYSTEMS, MOUNTING DEVICES, CLAMPING DEVICES AND GROUND LUGS FOR USE WITH PHOTOVOLTAIC MODULES AND PANELS - COMPONENT  
See Addendum Page for Product Designation(s).

Have been evaluated by UL in accordance with the component requirements in the Standard(s) indicated on this Certificate. UL Recognized components are incomplete in certain constructional features or restricted in performance capabilities and are intended for installation in complete equipment submitted for investigation to UL LLC.

**Standard(s) for Safety:** UL 2703, Mounting systems, mounting devices, clamping/retention devices, and ground lugs for use with flat-plate photovoltaic modules and panels-.

**Additional Information:** See the UL Online Certifications Directory at <https://iq.ulprospector.com> for additional information

This Certificate of Compliance indicates that representative samples of the product described in the certification report have met the requirements for UL certification. It does not provide authorization to apply the UL Recognized Component Mark. Only the Authorization Page that references the Follow-Up Services Procedure for ongoing surveillance provides authorization to apply the UL Mark.

Only those products bearing the UL Recognized Component Mark should be considered as being UL Certified and covered under UL's Follow-Up Services.

Look for the UL Recognized Component Mark on the product.



Deborah Jennings-Conner, VP Regulatory Services

UL LLC

Any information and documentation involving UL Mark services are provided on behalf of UL LLC (UL) or any authorized licensee of UL. For questions, please contact a local UL Customer Service Representative at <http://ul.com/aboutul/locations/>



# CERTIFICATE OF COMPLIANCE

**Certificate Number** E493748  
**Report Reference** E493748-20170817  
**Date** 2023-April-07

This is to certify that representative samples of the product as specified on this certificate were tested according to the current UL requirements

**Models:**

USR – Component, Roof Mounting Hook Units, Models 15891 15893 15987 16000 16317 16318 16319 16320 16988 16990 16991 16993 17508 17509 17510 17511 17512 17513 17514 17515 17516 17517 17518 17519 17520 17521 17522 17523 17524 17525 17526 17527 17536 17537 17538 17539 17540 17541 17542 17543 17544 17545 17546 17547 17548 17549 17550 17551 17552 17553 17554 17555 17556 17558 17559 17560 17566 17567 17568 17569 17570 17571 17572 17573 17574 17575 17576 17577 17578 17579 17580 17585 17586 17587 17588 17589 17592 17596 17597 17598 17599 17600 17601 17606 17607 17608 17609 17610 17611 17612 17613 17614 17615 17616 17617 17618 17620 17621 17622 17623 17624 17625 17626 17627 17628 17629 17630 17631 17632 17633 17636 17637 17638 17639 17640 17641 17642 17643 17646 17647 17648 17649 17650 17651 17652 17653 17654 17659 17664 17667 17669 17670 17671 17672 17673 17678 17679 17680 17681 17686 17687 17688 17689 17700 17701 17702 17703 17704 17705 17706 17707 17708 17709 17710 17711 17712 17717 17718 17750 17751 17752 17753 17759 15891-10 15891BLK-10 15987A 15987B 17667SS 17672SS 17680SS 17688SS 17713SS 17720 17721SS 17723 17724SS 17726 17727SS 17729 17730SS 15894SS 15891SS 15987BSS 17660 17661 17662 17663 17747 17748

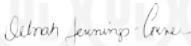

Deborah Jennings-Conner, VP Regulatory Services

UL LLC

Any information and documentation involving UL Mark services are provided on behalf of UL LLC (UL) or any authorized licensee of UL. For questions, please contact a local UL Customer Service Representative at <http://ul.com/aboutul/locations/>



# INSTALL INSTRUCTIONS

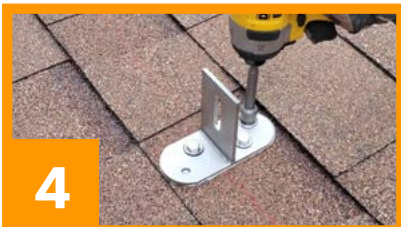

## BUTYL BOTTOM DECK MOUNT (16319) RECOMMENDED MATERIALS

- 1/2" Nut Setter

## INSTALLATION INSTRUCTIONS

Install anywhere on roof. No need to locate rafters

1. Remove butyl tape from bottom of T-Foot
2. Place T-Foot on roof and press firmly into place
3. Insert first 5/16 X 2 1/2" Hex Lag into T-Foot and drive the screw until the washer is compressed
4. Repeat with remaining screws

- \* Do not predrill
- \* To Drive Screws and Set Umbrella Washers Properly Torque PSI should not Exceed 57 Lbs/Inch



# BUILDING CODE LETTER



March 22<sup>nd</sup>, 2023

To whom this may concern,

QuickBOLT is committed to excellence. The parts tested are durable goods, meaning the material composition and detailed specifications of the parts do not change. Therefore, all stamps are current. Any part tested will have the same results no matter what year the tests are performed. All testing and reports are current and valid with 2022 CBC standards.

SolarRoofHook is the previous name of QuickBOLT. Any test result referencing SolarRoofHook is referring to a QuickBOLT product.

All our parts were tested by a third-party test facility, in possession of a current engineering license for the state where the tests were performed for the following.

1. Uplift test
2. Downward load test
3. Lateral Test – Asphalt Mounts, and Metal Mounts only
4. ASTM E2440 and ASTM E330 Waterproof Tests - QuickBOLT only

The following is an excerpt from:

CALIFORNIA BOARD FOR PROFESSIONAL ENGINEERS AND LAND SURVEYORS  
guide to Engineering & Land Surveying for City and County Officials  
Page 12, Line 27

**27. If the license has expired between the time the engineering documents were prepared and the time when the local agency's review is performed, do the documents need to be re-sealed by a licensee with a current license? (B&P Code §§ 6733, 6735, 6735.3, 6735.4)**

**As long as the license was current at the time the engineering documents were prepared, the documents do not need to be re-sealed prior to review by the local agency. However, any changes (updates or modifications) to the documents that are made following the review by the local agency would have to be prepared by a licensed engineer with a current license and those changes would have to be signed and sealed.**

We trust the information provided will resolve any request for the test reports submitted to have a stamp from the current year.

Regards,

Rick Gentry  
Executive Vice President

# ENGINEERING REPORT #1

## LOAD TESTING - DIRECT TO DECK



APPLIED MATERIALS & ENGINEERING, INC.

980 41<sup>st</sup> Street  
Oakland, CA 94608

Tel: (510) 420-8190  
FAX: (510) 420-8186  
e-mail: [info@apprmateng.com](mailto:info@apprmateng.com)

January 21, 2023

Project No.: 1220938C

Mr. Rick Gentry  
**QUICKSCREWS INTERNATIONAL**  
5830 Las Positas Road  
Livermore, CA 94551

**Subject:** Deck Mount Butyl Kit 36M-144S/CS (Part # 16319, 16320) Laboratory Load Testing

Dear Mr. Gentry:

As requested, Applied Materials & Engineering, Inc. (AME) has completed load-testing the Deck Mount Butyl Kit 36M-144S/CS (Part # 16319). The purpose of our testing was to evaluate the tensile and shear load capacity of the Deck Mount attached to 1/2" OSB using four (4) 5/16"Øx2-1/2" lag screws.

### SAMPLE DESCRIPTION

Six Deck Mount Butyl Kits were delivered to our laboratory on January 18, 2022. Mockup configuration consisted of two 12" long rafters screwed to 1/2" OSB. The Deck Mount is attached through the OSB between the rafters with four 5/16"Øx2-1/2" lag screws.

### TEST PROCEDURES & RESULTS

#### 1. Tensile Load Test

A total of three tests were conducted for tensile (uplift) load capacity on January 20, 2023 using a United Universal testing machine. Samples were rigidly attached to the testing machine and a tensile load was applied to the hook. The samples were loaded in tension at a constant rate of axial deformation of 0.10 in./min. without shock until failure occurred; displacement at maximum load was recorded. Based on the above testing, the average maximum tensile load and displacement of the Deck Mount Butyl Kit attached to 1/2" OSB using four 5/16"Øx2-1/2" lag screws was determined to be 843 lbf and 0.4 in., respectively. Detailed results are provided in Table I and tensile load vs. displacement curves are provided in Figure 1. Test setup and mode of failure are provided in Appendix A, Figure 3.

#### 2. Shear Load Test Parallel to Rafter

A total of three tests were conducted for shear load capacity parallel to the rafter on January 21, 2023 using a United Universal testing machine. Samples were rigidly attached to the testing machine and a tensile load was applied to the hook. The samples were loaded in compression at a constant rate of axial deformation of 0.10 in./min. without shock until failure occurred; displacement at maximum load was recorded. Based on the above testing, the average maximum tensile load and displacement of the Deck Mount Butyl Kit attached to 1/2" OSB using four 5/16"Øx2-1/2" lag screws was determined to be 1555 lbs and 0.9 in., respectively. Detailed results are provided in Table II and shear load vs. displacement curves are provided in Figure 2. Test setup and mode of failure are provided in Appendix A, Figure 4.

APPLIED MATERIALS & ENGINEERING, INC.

Mr. Rick Gentry

**QUICKSCREWS INTERNATIONAL**

Deck Mount Butyl Kit 36M-144S/CS (Part # 16319, 16320) Laboratory Load Testing

January 21, 2023

Page 2

Respectfully Submitted,

**APPLIED MATERIALS & ENGINEERING, INC.**

Reviewed by:

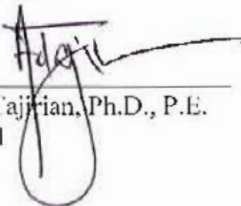
  
\_\_\_\_\_  
Armen Tajirian, Ph.D., P.E.  
Principal



**APPLIED MATERIALS & ENGINEERING, INC.**

**TABLE 1**

**TENSILE (UPLIFT) LOAD TEST RESULTS**

**DECK MOUNT BUTYL KIT 36M-144S/CS (Part # 16319, 16320)**

**PROJECT NUMBER 1220938C**

<b>TEST NUMBER</b>	<b>MAXIMUM TENSILE LOAD (lbf)</b>	<b>DISPLACEMENT AT MAXIMUM LOAD (in.)</b>	<b>MODE OF FAILURE</b>
8269	818	0.4	Lag Screw Pull-out
8270	868	0.3	
8271	843	0.5	
<b>AVERAGE</b>	<b>843</b>	<b>0.4</b>	<b>**</b>

**TABLE II**

**SHEAR LOAD TEST RESULTS**

**DECK MOUNT BUTYL KIT 36M-144S/CS (Part # 16319, 16320)**

**PROJECT NUMBER 1220938C**

<b>TEST NUMBER</b>	<b>MAXIMUM TENSILE LOAD (lbf)</b>	<b>DISPLACEMENT AT MAXIMUM LOAD (in.)</b>	<b>MODE OF FAILURE</b>
8272	1751	1.1	Lag Screw Pull-out
8273	1458	0.7	
8274	1457	0.8	
<b>AVERAGE</b>	<b>1555</b>	<b>0.9</b>	<b>..</b>

TENSILE LOAD-DISPLACEMENT CURVES



APPLIED MATERIALS & ENGINEERING, INC.

Report No 1668      Tensile Test - XHD Control

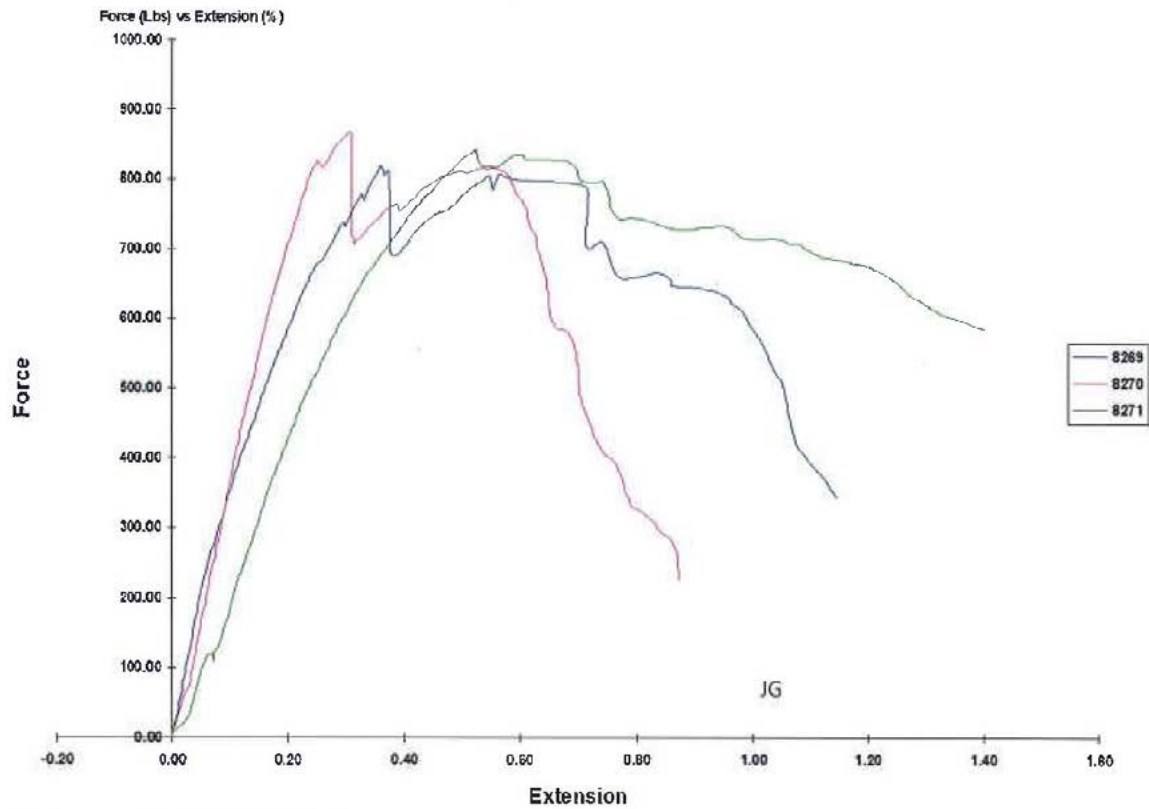

Template 7      Testing Machine SMART Tests      By \_\_\_\_\_  
Jan 21, 2023      Applied Materials & Engineering    080 41st. Street    Oakland, CA 94542    TEL    FAX

Figure 1. Test 8269, 8270, 8271 tensile load vs. displacement curve.

SHEAR LOAD-DISPLACEMENT CURVES



Report No 1669      Compression Testing

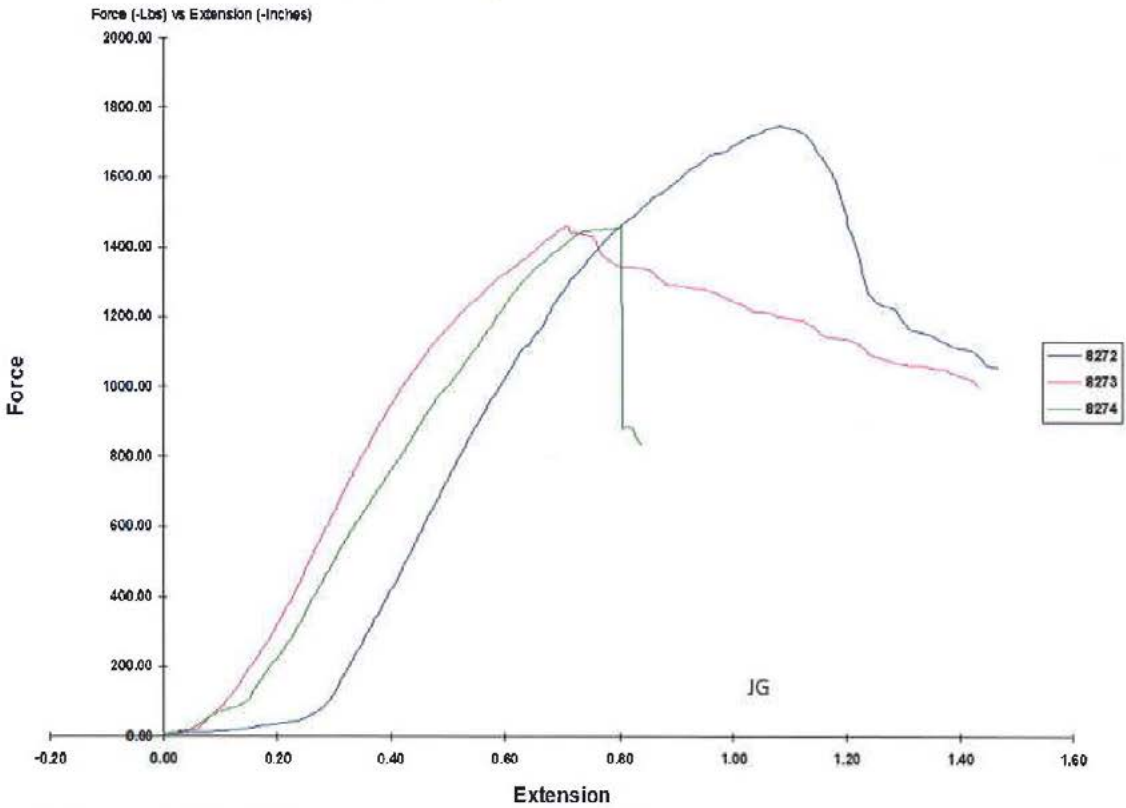

Template 121      Testing Machine SMART Teste      By : \_\_\_\_\_  
Jan 21, 2023      Applied Materials & Engineering    980 41st. Street    Oakland, CA 94642    TEL    FAX

Figure 2. Test 8272, 8273, 8274 shear load vs. displacement curve.

**FIGURE 3**

**DECK MOUNT BUTYL KIT 36M-144S/CS (Part # 16319, 16320)**

**TENSILE (UPLIFT) LOAD TEST SETUP**

**PROJECT NUMBER 1220938C**



**Figure 3a. Test setup.**



**Figure 3b. Typical failure mode.**



**Figure 3c. Lag screw view of typical failure.**

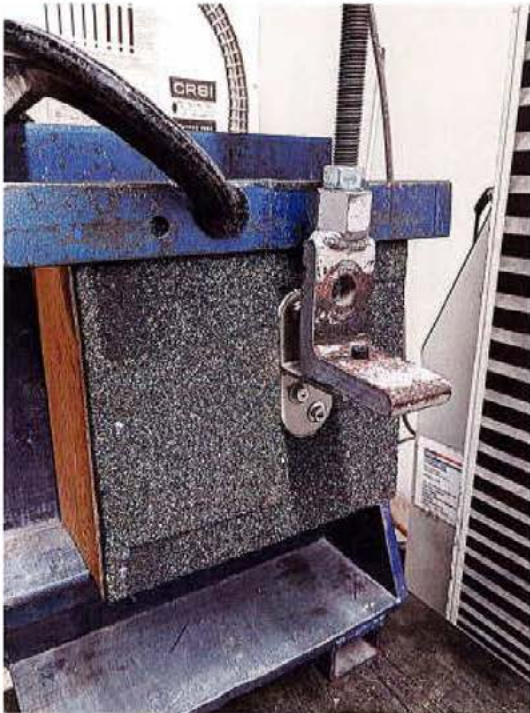

**FIGURE 4**

**DECK MOUNT BUTYL KIT 36M-144S/CS (Part # 16319, 16320)**

**SHEAR LOAD TEST SETUP**

**PROJECT NUMBER 1220938C**



**Figure 4a. Test setup.**



**Figure 4b. Mount failure mode.**

# ENGINEERING REPORT #2

## LOAD TESTING - RAFTER MOUNTED



APPLIED MATERIALS & ENGINEERING, INC.

980 41<sup>st</sup> Street  
Oakland, CA 94608

Tel: (510) 420-8190  
FAX: (510) 420-8186  
e-mail: info@appmateng.com

January 4, 2023

Mr. Rick Gentry  
**QUICKSCREWS INTERNATIONAL**  
5830 Las Positas Road  
Livermore, CA 94551

Project Number 1220938C

**Subject:** Deck Mount Butyl Kit 36M-144S/CS (Part # 16319, 16320) Laboratory Load Testing

Dear Mr. Gentry:

As requested, Applied Materials & Engineering, Inc. (AME) has completed load-testing the Deck Mount Butyl Kit 36M-144S/CS (Part # 16319). The purpose of our testing was to evaluate the tensile and shear load capacity of the Deck Mount attached to a 2"x6" Douglas Fir rafter using four (4) 5/16"Øx2-1/2" lag screws.

### **SAMPLE DESCRIPTION**

Six Deck Mount Butyl Kits with 2"x6" Douglas Fir samples were delivered to our laboratory on December 9, 2022. Mockup configuration consisted of three 12" long rafters at 6.5" o.c., screwed to 1/2" Structural I plywood. The Deck Mount is attached through the plywood into a rafter with four 5/16"Øx2-1/2" lag screws.

### **TEST PROCEDURES & RESULTS**

#### **1. Tensile Load Test**

A total of three tests were conducted for tensile (uplift) load capacity on December 28, 2022 using a United Universal testing machine. Samples were rigidly attached to the testing machine and a tensile load was applied to the hook. The samples were loaded in tension at a constant rate of axial deformation of 0.10 in./min. without shock until failure occurred; displacement at maximum load was recorded. Based on the above testing, the average maximum tensile load and displacement of the Deck Mount Butyl Kit attached to a 2"x6" Douglas Fir rafter using four 5/16"Øx2-1/2" lag screws was determined to be 3238 lbf and 0.4 in., respectively. Detailed results are provided in Table I and tensile load vs. displacement curves are provided in Figure 1. Test setup and mode of failure are provided in Appendix A, Figure 3.

The specific gravity and moisture content of the rafter was tested in accordance with ASTM D2395, Method A (oven-dry). The average specific gravity and moisture content were determined to be 0.493 and 16.3%, respectively.

Mr. Rick Gentry

**Quickscrews International**

Deck Mount Butyl Kit 36M-144S/CS (Part # 16319, 16320) Laboratory Load Testing

January 4, 2023

**3. Shear Load Test Parallel to Rafter**

A total of three tests were conducted for shear load capacity parallel to the rafter on December 29, 2022 using a United Universal testing machine. Samples were rigidly attached to the testing machine and a tensile load was applied to the hook. The samples were loaded in compression at a constant rate of axial deformation of 0.10 in. /min. without shock until failure occurred; displacement at maximum load was recorded. Based on the above testing, the average maximum tensile load and displacement of the Deck Mount Butyl Kit attached to a 2"x6" Douglas Fir rafter using four 5/16"Øx2-1/2" lag screws was determined to be 5234 lbs and 2.1 in., respectively. Detailed results are provided in Table II and shear load vs. displacement curves are provided in Figure 2. Test setup and mode of failure are provided in Appendix A, Figure 4.

The specific gravity and moisture content of the rafter was tested in accordance with ASTM D2395, Method A (oven-dry). The average specific gravity and moisture content were determined to be 0.448 and 17.7%, respectively.

Respectfully Submitted,

**APPLIED MATERIALS & ENGINEERING, INC.**

**Reviewed by:**

---

Armen Tajirian, Ph.D., P.E.  
Principal

**TABLE 1**

**TENSILE (UPLIFT) LOAD TEST RESULTS**

**DECK MOUNT BUTYL KIT 36M-144S/CS (Part # 16319, 16320)**

**PROJECT NUMBER 1220938C**

<b>TEST NUMBER</b>	<b>MAXIMUM TENSILE LOAD (lbf)</b>	<b>DISPLACEMENT AT MAXIMUM LOAD (in.)</b>	<b>MODE OF FAILURE</b>	<b>RAFTER SPECIFIC GRAVITY</b>	<b>RAFTER MOISTURE CONTENT (%)</b>
8173	3613	0.4	Rafter Split	0.508	15.4
8174	2949	0.4		0.411	19.2
8175	3153	0.3		0.560	14.2
<b>AVERAGE</b>	<b>3238</b>	<b>0.4</b>	<b>..</b>	<b>0.493</b>	<b>16.3</b>

TENSILE LOAD-DISPLACEMENT CURVES



Report No 1639 Tensile Test - XHD Control

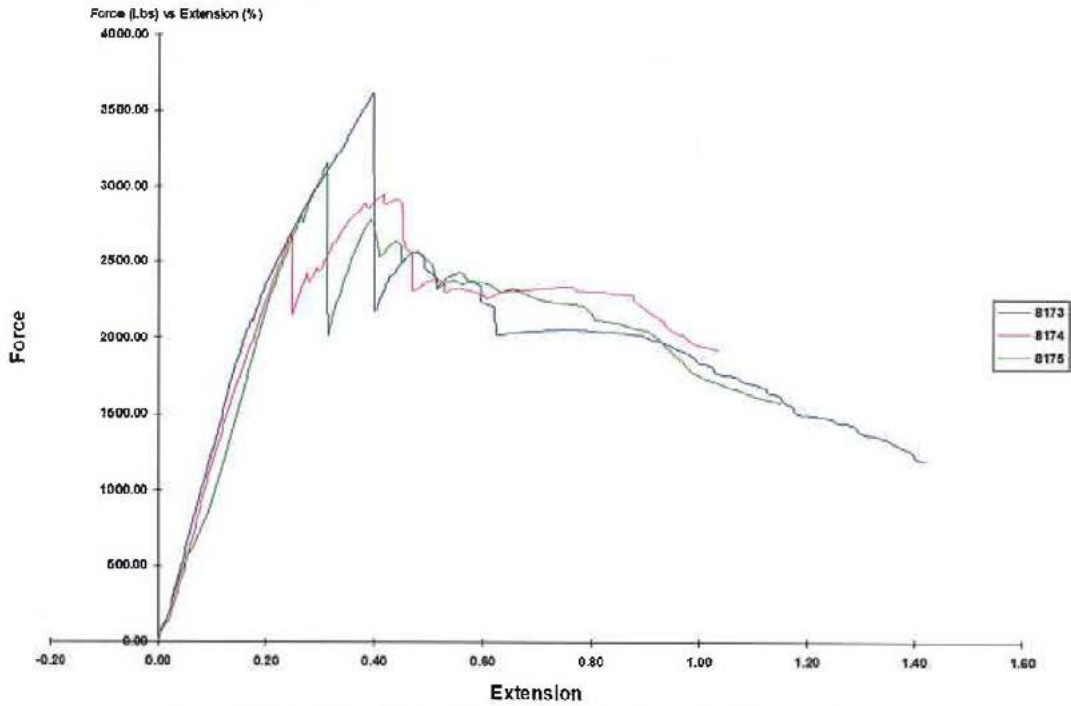

Figure 1. Test 8173, 8174, 8175 tensile load vs. displacement curve.

**TABLE II**

**SHEAR LOAD TEST RESULTS**

**DECK MOUNT BUTYL KIT 36M-144S/CS (Part # 16319, 16320)**

**PROJECT NUMBER 1220938C**

<b>TEST NUMBER</b>	<b>MAXIMUM SHEAR LOAD (lbf)</b>	<b>DISPLACEMENT AT MAXIMUM LOAD (in.)</b>	<b>MODE OF FAILURE</b>	<b>RAFTER SPECIFIC GRAVITY</b>	<b>RAFTER MOISTURE CONTENT (%)</b>
8176	7180	2.5	Bolt Shear	0.425	18.4
8177	4744	2.0	Mount Break	0.518	15.0
8178	3778	1.9	Mount Break	0.400	19.9
<b>AVERAGE</b>	<b>5234</b>	<b>2.1</b>	<b>..</b>	<b>0.448</b>	<b>17.7</b>

SHEAR LOAD-DISPLACEMENT CURVES



Report No 1640      Compressive Test - XHD Control  
Force (-Lbs) vs Extension (-Inches)

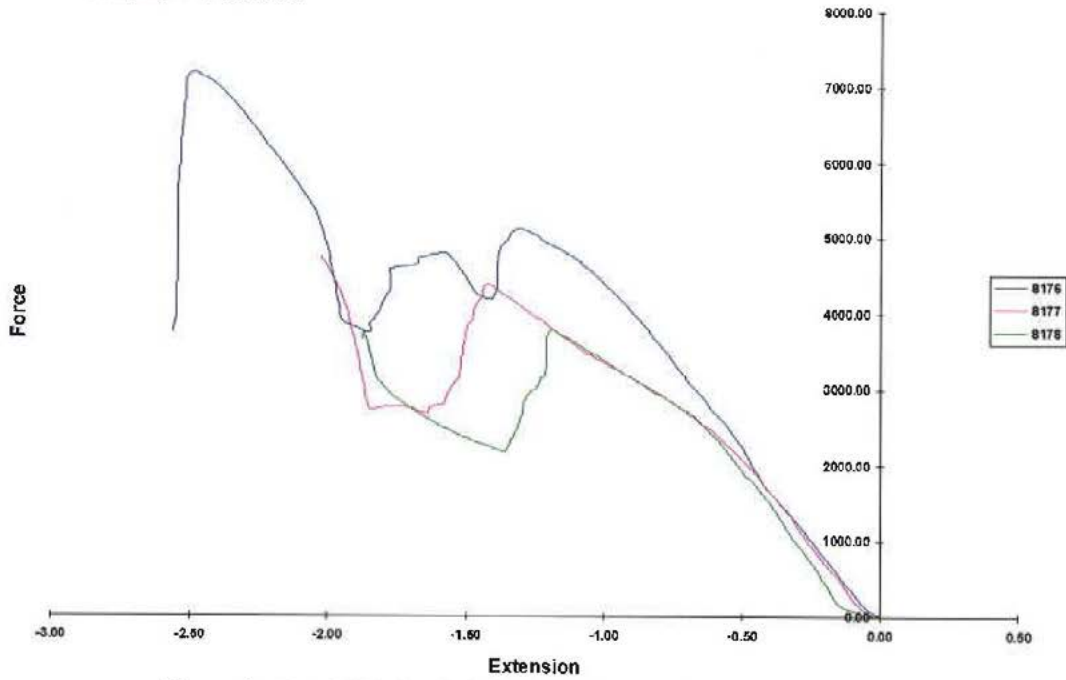

Figure 2. Test 8176, 8177, 8178 shear load vs. displacement curve.

**FIGURE 3**

**DECK MOUNT BUTYL KIT 36M-144S/CS (Part # 16319, 16320)**

**TENSILE (UPLIFT) LOAD TEST SETUP**

**PROJECT NUMBER 1220938C**



**Figure 3a.** Test setup.

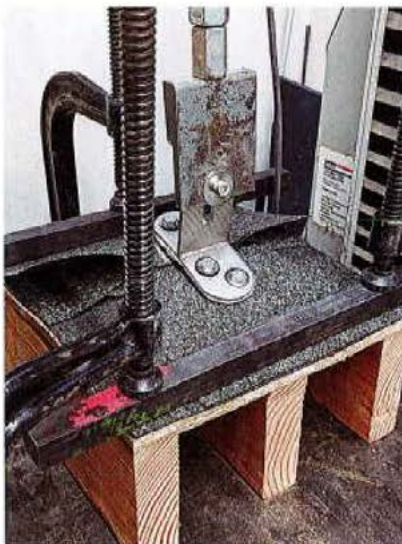

**Figure 3b.** Typical failure mode.

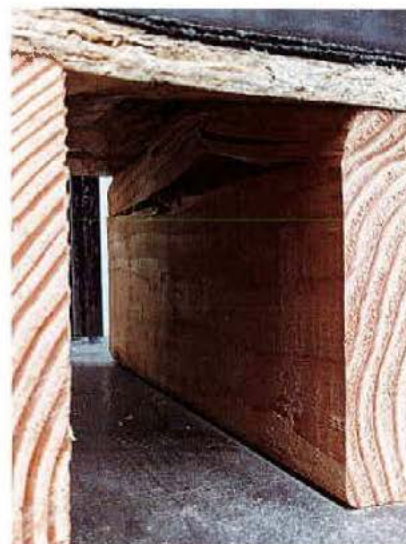

**Figure 3c.** Rafter view of typical failure



**FIGURE 4**

**DECK MOUNT BUTYL KIT 36M-144S/CS (Part # 16319, 16320)**

**SHEAR LOAD TEST SETUP**

**PROJECT NUMBER 1220938C**



**Figure 4a.** Test setup.



**Figure 4b.** Mount failure mode.



**Figure 4c.** Bolt failure mode.